

434 MHz SINGLE-ENDED ANTENNA MATRIX MEASUREMENT REPORTS

INTRODUCTION

This document summarizes the measured results of the antennas applied in the Silicon Labs 434 MHz antenna matrix (WES0070-01-AMS434-01).

- The antennas are realized on a 1.55 mm thick FR4.
- Target antenna impedance is 50 Ω .

A picture of the WES0070-01-AMS434-01 434 MHz Antenna Matrix is shown in Figure 1. For the 434 MHz band, eight different PCB antenna solutions are proposed:

- Medium Sized Printed IFA around the PCB circumference (WES0071-01-APF434M-01)
- Ceramic (Chip) Antenna (WES0072-01-ACM434D-01)
- Printed BIFA antenna in a dedicated bigger antenna area (WES0073-01-APB434D-01)
- Medium Sized (Wire) Helical Antenna (WES0074-01-AWH434M-01)
- Panic Button IFA (Printed) along the circumference (WES0075-01-APF434P-01)
- Panic Button ILA (Printed) along the circumference (WES0076-01-APL434P-01)
- Printed Meander Monopole (WES0077-01-APN434D-01)
- Small Sized Printed ILA (or optional IFA) in dedicated small antenna area (WES0078-01-APL434S-01)

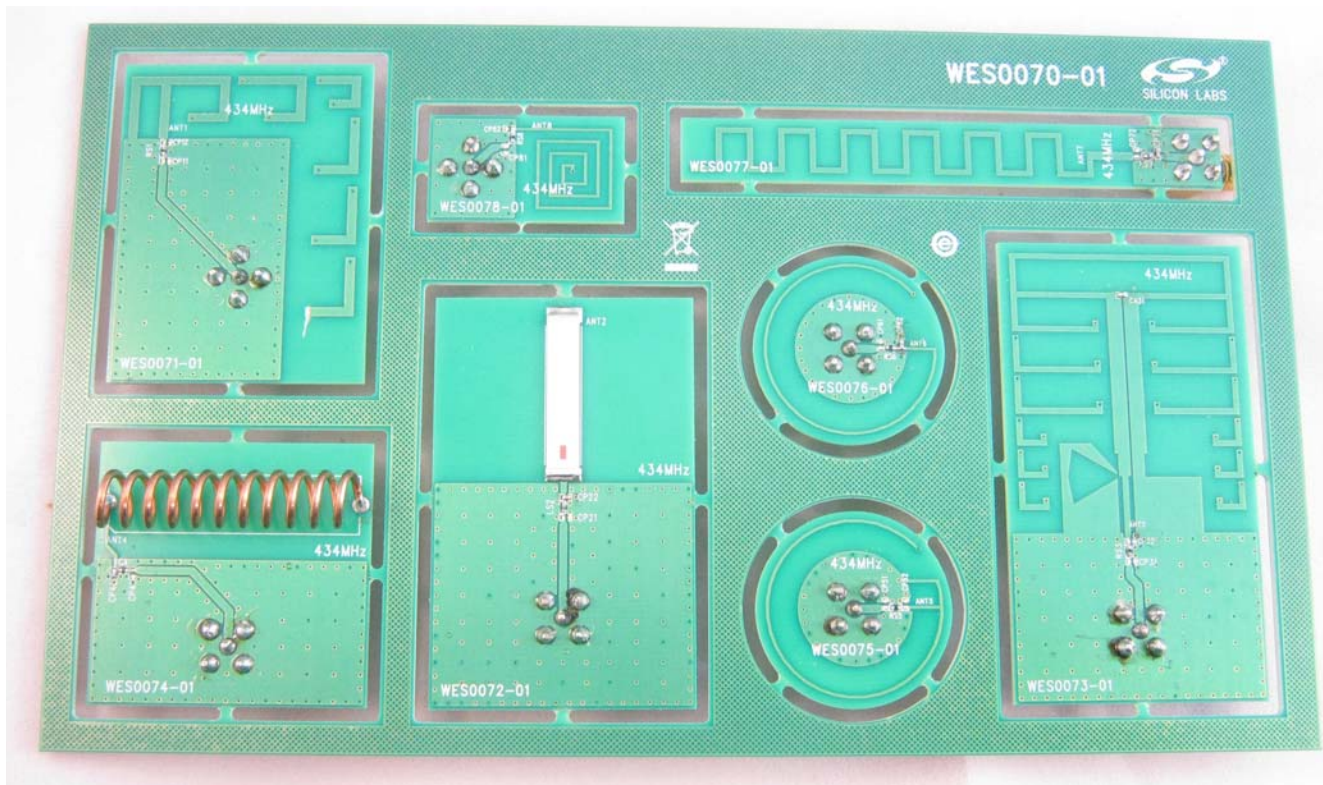


Figure 1. 434 M 50 Ω , Single-ended Antenna Matrix (WES0070-01-AMS434-01)

1. Antenna Results Summary

The performance of the 434 M single-ended matrix antennas are compared in Table 1.

Table 1. Antenna Results Comparison

434 M Single-ended Antenna Type	External Match	Maximum EIRP [dBm] ¹	Maximum Antenna Gain [dBi]	Maximum Range Outdoor [m] ²	Estimated Average Indoor Range [m] ³
Medium Sized IFA (WES0071)	No	9.3	0.3	1548	83
Ceramic Antenna (WES0072)	Yes	7.1	-1.9	1308	51
BIFA (WES0073)	Yes	3.2	-5.8	885	60
Medium Sized Helical (WES0074)	Yes	12	3	1350	112
Panic Button IFA (WES0075)	No	4	-5	1125	53
Panic Button ILA (WES0076)	Yes	4.8	-4.2	1041	58
Printed Meandered Ant. (WES0077)	Yes	12.1	3.1	1529	143
Small Sized ILA (WES0078)	No	0.5	-8.5	650	31

Notes:

1. With the 4460PCE10D434 Pico Board and WMB-930 Wireless Motherboard working from two AA batteries (~2.9 V). Delivered power to the antenna is ~9 dBm.
2. This value is the highest outdoor range achieved with the pair of identical antennas with 9 dBm TX power and 40 kbps, 20 kHz deviation, ~88 kHz RX bandwidth. 1% PER with ten byte long packets. In some cases the antenna direction found for maximum range is different from the direction of the maximum in the pattern measurements. The range test was conducted with a hand effect on the motherboard, while the pattern measurements were done without any hand effect.
3. To the normal direction of usage (X-axes facing to each other; see antenna chapters).

Detailed Antenna Measurement Results

2. Medium Sized Printed IFA (WES0071-01-APF434M-01)

No external matching is required for this antenna. In the antenna PCB, a series 0 Ω resistor connects the antenna input to the feeding 50 Ω coplanar line. The footprint for two additional parallel matching elements is unpopulated.

The matching network schematic is shown in Figure 3.

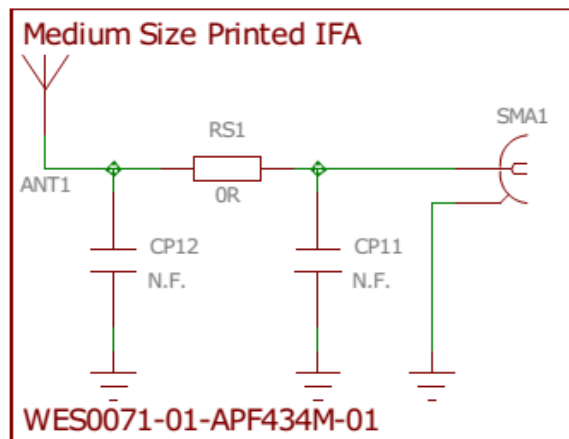


Figure 2. Medium Sized IFA Board (WES0071-01-APF434M-01) Antenna Matching Network Schematic

The Medium Sized IFA antenna is shown in Figure 3.

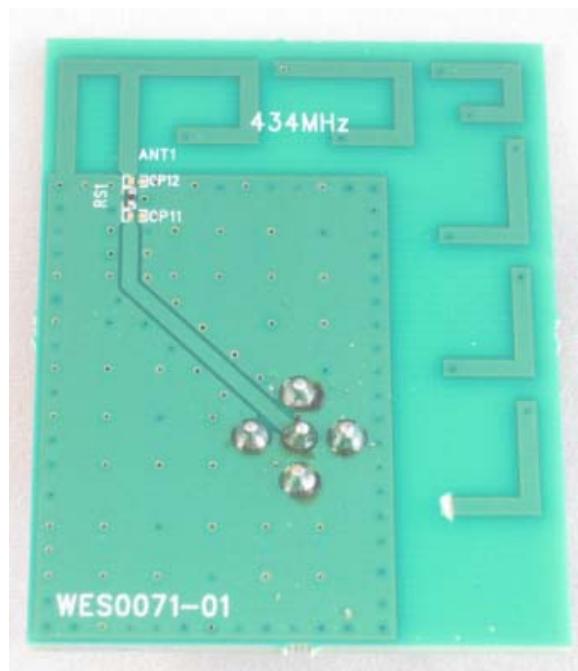


Figure 3. Medium Sized Printed IFA Antenna

2.1. Antenna Impedance (WES0071-01-APF434M-01)

The impedance measurement setup is shown in Figure 4. The antenna board is connected to the 4455-PCE10D434 Pico Board through a male-to-male SMA transition with the WMB-930 Wireless Motherboard driving the Pico Board.

During the impedance tuning and range test, the user's hand holds the motherboard. A typical hand position is shown in Figure 5.



Figure 4. DUT in the Impedance Measurement Setup (WES0071 Medium IFA Board)

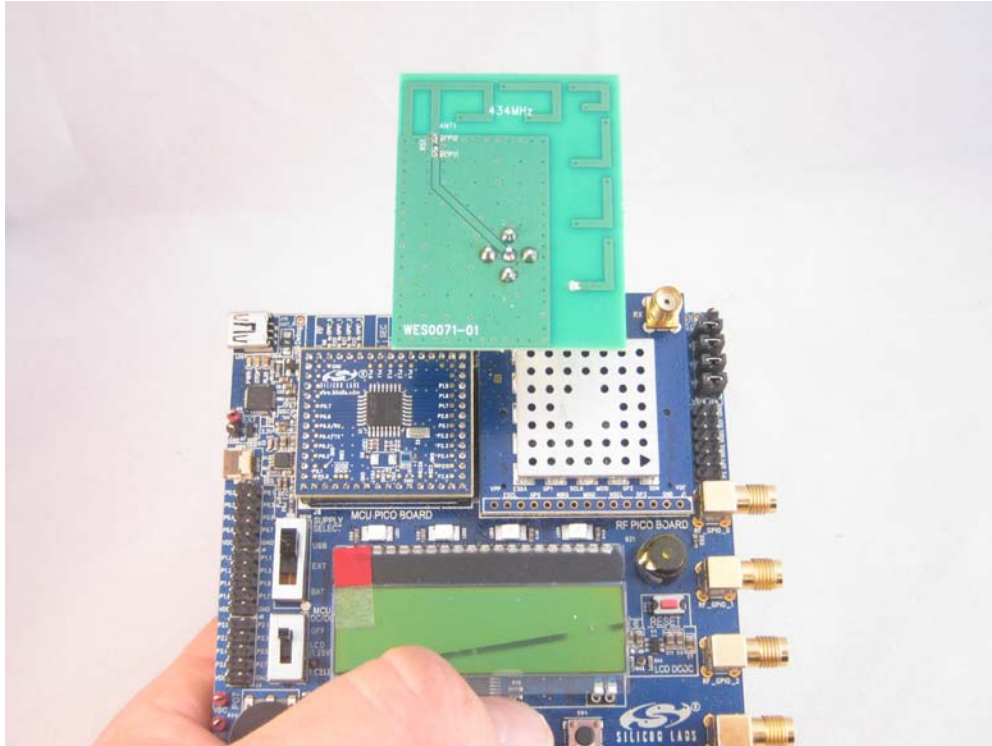


Figure 5. Typical Hand Effect on the Main Board During Impedance and Range Measurement (Medium IFA Antenna [WES0071] Board)

The measured impedance of the antenna is shown in Figure 6 (up to 1.5 GHz) with motherboard hand effect.

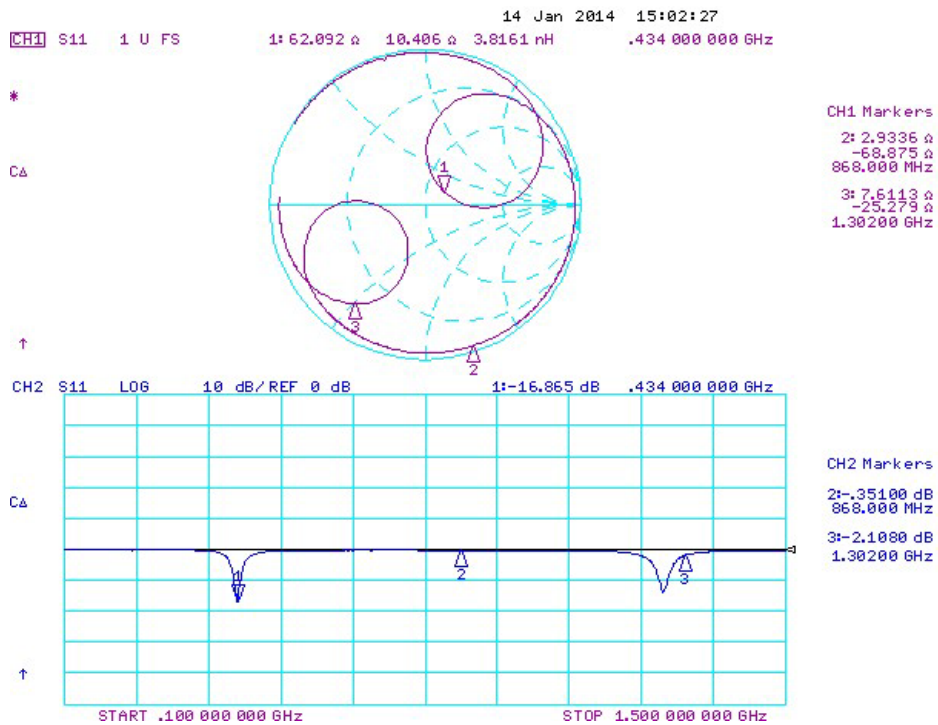


Figure 6. Measured Impedance up to 1.5 GHz with Hand Effect on the Main Board

2.2. Antenna Gain (WES0071-01-APF434M-01)

The antenna gain is calculated both from the measured radiated power at the fundamental and from the delivered power to the antenna. In the radiation measurement, a P4455-PCE10D434 Pico Board drives the antenna with $\sim +9$ dBm due to the reduced V_{DD} (power state 0x4F and ~ 2.9 V V_{DD}) of the applied two AA batteries. The conducted SA measurement result of the 4455-PCE10D434 Pico Board in this reduced power state is shown in Figure 7. This method can be effectively applied because the S11 of the antenna is much better than -10 dB, so the reflection loss is negligible.

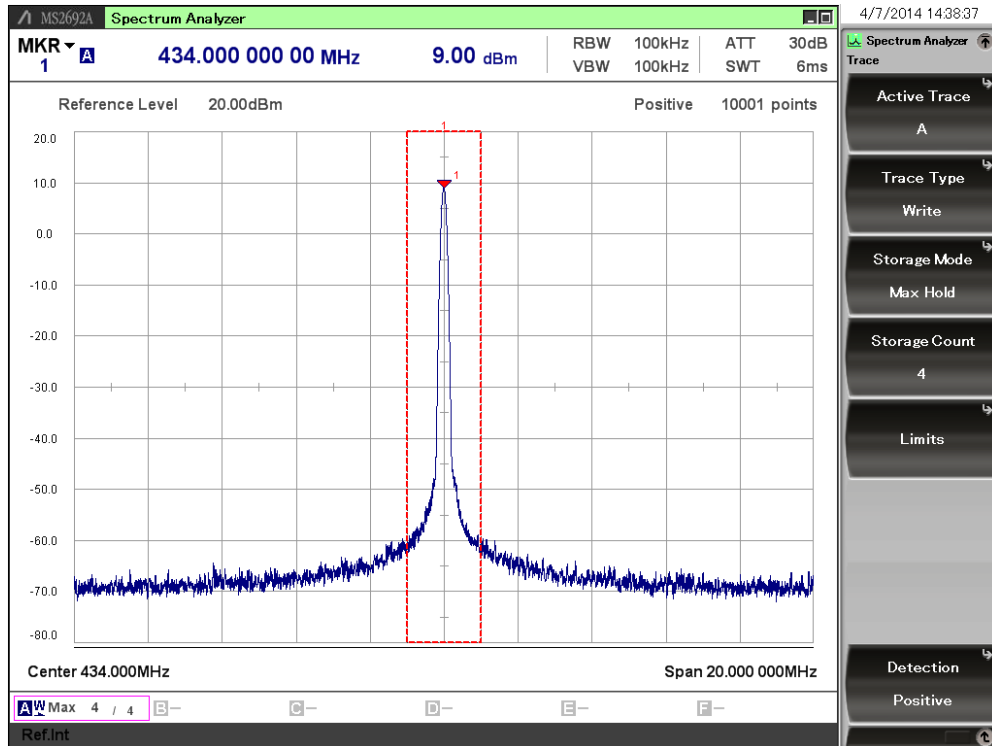


Figure 7. Conducted Measurement Result, 4455-PCE10B434 in a Reduced (~ 9 dBm) Power Level: the State is 0x4F and V_{DD} is ~ 2.9 V (Two AA Batteries)

The measured radiated power maximum is at the XZ cut (Table 2). It is around 9.3 dBm EIRP, so the maximum gain number is $+0.3$ dBi, as shown in Figure 12.

2.3. Radiation Patterns (WES0071-01-APF434M-01)

The radiation patterns of the medium sized printed IFA antenna were measured in an antenna chamber with the 4455-PCE10D434 Pico Board connected through a male-to-male SMA transition and with the WMB-930 Wireless Motherboard driving the Pico Board. Figure 9—Figure 14 show the radiation patterns at the fundamental frequency in the XY, XZ, YZ cut, with both horizontal and vertical receiver antenna polarization. The rotator was stepped in five degrees to record the radiation pattern in 360 degrees.

Figure 8 shows the device under test (DUT) with coordinate system under the radiated measurements. In the XY cut the rotation starts from the X-axis, while in the XZ and YZ cuts rotation starts from the Z-axis.

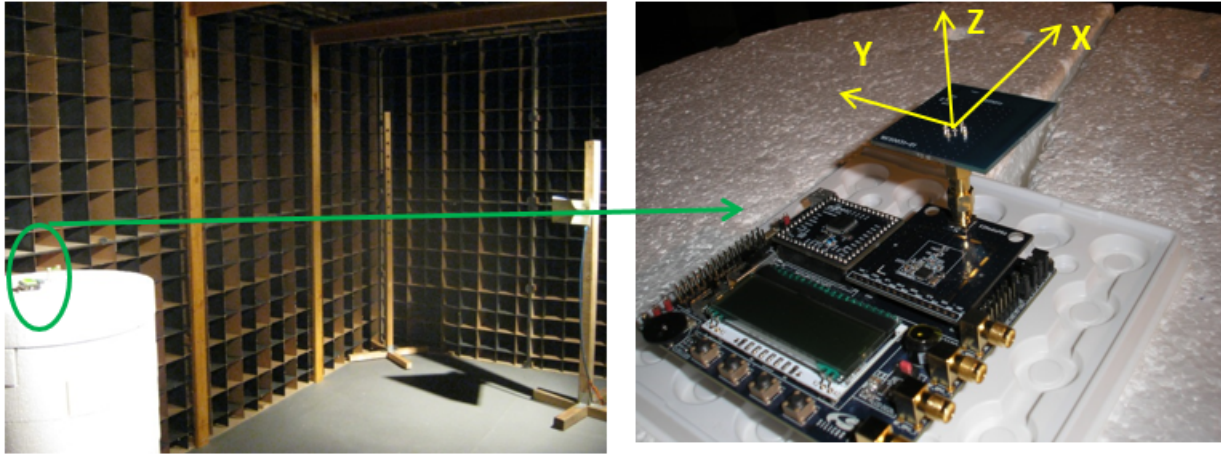


Figure 8. DUT in the Antenna Chamber

The measured radiation patterns (antenna gain in dBi) are shown in the following six figures (Figure 9–Figure 14).

**Radiation Pattern in dBi, 434MHz Medium
IFA XYV**

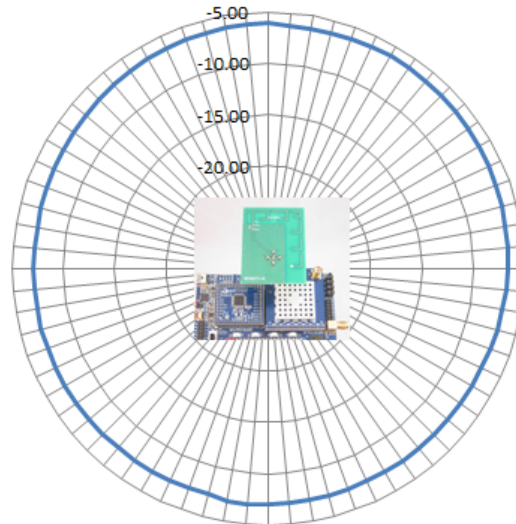


Figure 9. Radiation Pattern in the XY Cut with Vertical Receiver Antenna Polarization

**Radiation Pattern in dBi, 434MHz Medium
IFA XYH**

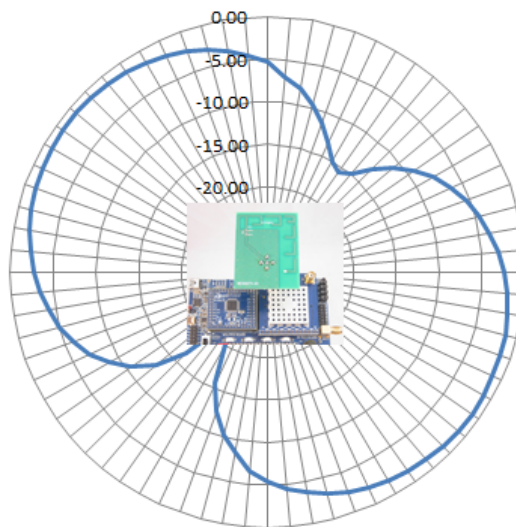


Figure 10. Radiation Pattern in the XY Cut with Horizontal Receiver Antenna Polarization

**Radiation Pattern in dBi, 434MHz Medium
IFA XZV**

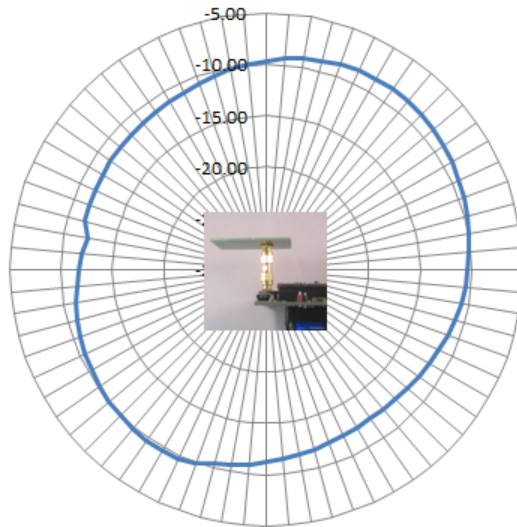


Figure 11. Radiation Pattern in the XZ Cut with Vertical Receiver Antenna Polarization

**Radiation Pattern in dBi, 434MHz Medium
IFA XZH**

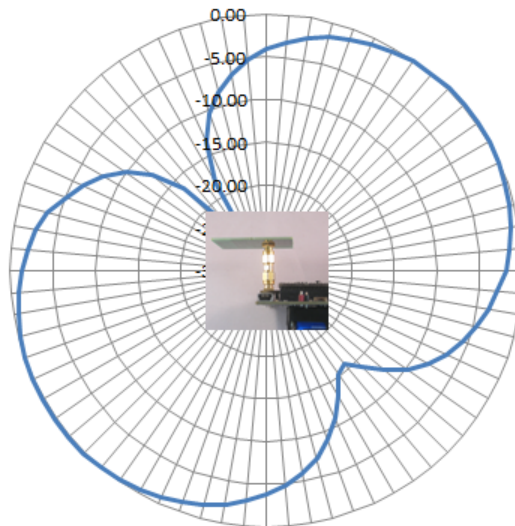


Figure 12. Radiation Pattern in the XZ Cut with Horizontal Receiver Antenna Polarization

**Radiation Pattern in dBi, 434MHz Medium
IFA YZV**

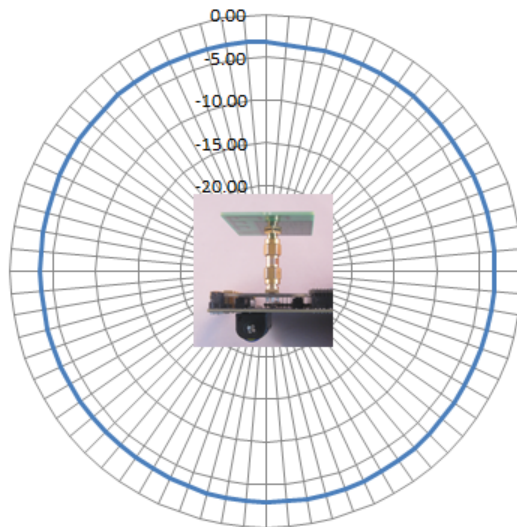


Figure 13. Radiation Pattern in the YZ Cut with Vertical Receiver Antenna Polarization

**Radiation Pattern in dBi, 434MHz Medium
IFA YZH**

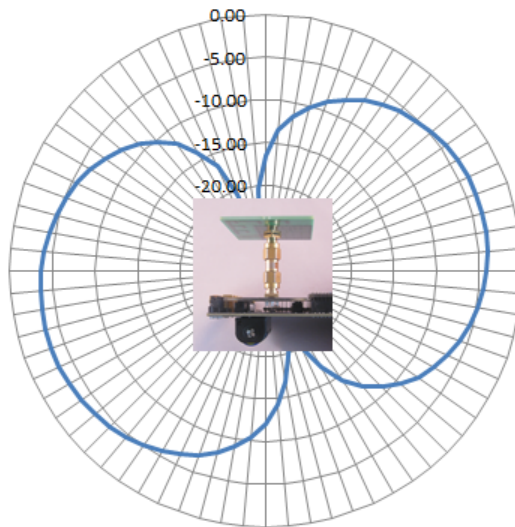


Figure 14. Radiation Pattern in the YZ Cut with Horizontal Receiver Antenna Polarization

2.4. Radiated Harmonics (WES0071-01-APF434M-01)

The radiated harmonics of the medium sized printed IFA antenna were also measured in an antenna chamber with the 4455-PCE10D434 Pico Board connected through a male-to-male SMA transition and with the WMB-930 Wireless Motherboard driving the Pico Board. The 4455-PCE10D434 Pico Board is set to a power state of 0x4F and a V_{DD} of ~2.9 V (two AA batteries) to deliver ~+9 dBm as Figure 7 shows. The maximum radiated power levels, up to the 10th harmonic, were measured in the XY, XZ, and YZ cut, with both horizontal and vertical polarized receiver antenna. The results are shown in the following EIRP table (Table 2) together with the corresponding standard limits.

The medium sized IFA antenna, driven by the Si4455/60 class E match at 10 dBm power settings complies with the ETSI harmonic regulations with margin.

In typical battery-operated final application, where the wireless motherboard is eliminated and the Pico Board layout is unified with the antenna, the harmonic radiation is likely lower.

Table 2. Radiated Harmonics, Medium IFA Board Connected to the 4460-PCE10D434 Output, Driven by the WMB-930 Wireless Motherboard

Cut.	Pol.	Freq.	f [MHz]	ETSI limit in EIRP [dBm]	Measured radiated power in EIRP [dBm]	Margin [dB]
XY	V	Fund.	434	12.14	2.92	9.2
XY	V	2 nd	868	-33.88	-65.92	32.0
XY	V	3 rd	1302	-27.86	-65.18	37.3
XY	V	4 th	1736	-27.86	-50.21	22.4
XY	V	5 th	2170	-27.86	-45.28	17.4
XY	V	6 th	2604	-27.86	-48.37	20.5
XY	V	7 th	3038	-27.86	-59.37	31.5
XY	V	8 th	3472	-27.86	-48.47	20.6
XY	V	9 th	3906	-27.86	-51.25	23.4
XY	V	10 th	4340	-27.86	-44.29	16.4
XY	H	Fund.	434	12.14	8.06	4.1
XY	H	2 nd	868	-33.88	-69.20	35.3
XY	H	3 rd	1302	-27.86	-70.42	42.6
XY	H	4 th	1736	-27.86	-53.27	25.4
XY	H	5 th	2170	-27.86	-51.06	23.2
XY	H	6 th	2604	-27.86	-44.91	17.1
XY	H	7 th	3038	-27.86	-58.85	31.0

Table 2. Radiated Harmonics, Medium IFA Board Connected to the 4460-PCE10D434 Output, Driven by the WMB-930 Wireless Motherboard(Continued)

Cut.	Pol.	Freq.	f [MHz]	ETSI limit in EIRP [dBm]	Measured radiated power in EIRP [dBm]	Margin [dB]
XY	H	8 th	3472	-27.86	-50.45	22.6
XY	H	9 th	3906	-27.86	-51.38	23.5
XY	H	10 th	4340	-27.86	-45.21	17.3
XZ	V	Fund.	434	12.14	0.47	11.7
XZ	V	2 nd	868	-33.88	-68.74	34.9
XZ	V	3 rd	1302	-27.86	-65.65	37.8
XZ	V	4 th	1736	-27.86	-50.33	22.5
XZ	V	5 th	2170	-27.86	-44.79	16.9
XZ	V	6 th	2604	-27.86	-42.88	15.0
XZ	V	7 th	3038	-27.86	-50.57	22.7
XZ	V	8 th	3472	-27.86	-47.24	19.4
XZ	V	9 th	3906	-27.86	-51.40	23.5
XZ	V	10 th	4340	-27.86	-39.35	11.5
XZ	H	Fund.	434	12.14	9.29	2.9
XZ	H	2 nd	868	-33.88	-68.96	35.1
XZ	H	3 rd	1302	-27.86	-68.82	41.0
XZ	H	4 th	1736	-27.86	-50.54	22.7
XZ	H	5 th	2170	-27.86	-44.70	16.8
XZ	H	6 th	2604	-27.86	-40.65	12.8
XZ	H	7 th	3038	-27.86	-50.90	23.0
XZ	H	8 th	3472	-27.86	-48.36	20.5
XZ	H	9 th	3906	-27.86	-51.70	23.8
XZ	H	10 th	4340	-27.86	-42.01	14.1
YZ	V	Fund.	434	12.14	6.12	6.0

Table 2. Radiated Harmonics, Medium IFA Board Connected to the 4460-PCE10D434 Output, Driven by the WMB-930 Wireless Motherboard(Continued)

Cut.	Pol.	Freq.	f [MHz]	ETSI limit in EIRP [dBm]	Measured radiated power in EIRP [dBm]	Margin [dB]
YZ	V	2 nd	868	-33.88	-68.22	34.3
YZ	V	3 rd	1302	-27.86	-66.02	38.2
YZ	V	4 th	1736	-27.86	-50.93	23.1
YZ	V	5 th	2170	-27.86	-47.06	19.2
YZ	V	6 th	2604	-27.86	-43.42	15.6
YZ	V	7 th	3038	-27.86	-50.82	23.0
YZ	V	8 th	3472	-27.86	-47.03	19.2
YZ	V	9 th	3906	-27.86	-51.33	23.5
YZ	V	10 th	4340	-27.86	-43.09	15.2
YZ	H	Fund.	434	12.14	5.73	6.4
YZ	H	2 nd	868	-33.88	-71.71	37.8
YZ	H	3 rd	1302	-27.86	-68.87	41.0
YZ	H	4 th	1736	-27.86	-52.26	24.4
YZ	H	5 th	2170	-27.86	-47.29	19.4
YZ	H	6 th	2604	-27.86	-39.74	11.9
YZ	H	7 th	3038	-27.86	-53.59	25.7
YZ	H	8 th	3472	-27.86	-48.61	20.7
YZ	H	9 th	3906	-27.86	-51.57	23.7
YZ	H	10 th	4340	-27.86	-42.00	14.1

2.5. Range Test (WES0071-01-APF434M-01)

The available range was measured using the Range Test Demo. This application is supplied with the standard development kits for EZRadioPRO®. The target of this measurement is to find the distance between the transceivers where the one-directional PER (Packet Error Rate, number of lost packets) is not more than 1% at each side with ten byte long packets. The GPS coordinates have been recorded for each spot. The distance between the spots has been measured using Google Maps, and results are shown in meters. The range was tested with two identical units held in hands according to Figure 5. Each unit comprises a WMB-930 Wireless Motherboard, a 4460-PCE10D434 Pico Board, and the DUT (as shown in Figure 5). In some tests the 4460-PCE10D434 Pico Board is set to +10 dBm TX power state, while in other tests it is set to 0 dBm. The nominal +10 dBm power setting (state of 0x2D) delivers +10 dBm power to the antenna at 3.3 V V_{DD} only. At 3 V V_{DD} supplied by the two AA batteries, the power level is lower, around +8.8 dBm. At the nominal 0 dBm setting (state of 0x07), the power decrease is negligible at 3 V V_{DD} .

The range was tested in a flat land area without obstacles.

During the range test, the following settings were used:

- Set 1: Txpow=10 dBm (~8.8 dBm @ 3 V V_{DD}), 40 kbps, 20 kHz dev., RXBW=82.64 kHz (sens ~-105.5 dBm)
- Set 2: Txpow=10 dBm (~8.8 dBm @ 3 V V_{DD}), 100 kbps, 50 kHz dev., RXBW=206.12 kHz (sens ~-100.7 dBm)
- Set 3: Txpow=0 dBm, 2.4 kbps, 2.4 kHz dev., RXBW=25.77 kHz (sens ~-115.9 dBm)

Using the settings above (Set 1, Set 2, and Set 3), the following range tests were made:

1. Range measurement with the MEDIUM IFA Antenna Boards—The antenna boards are HORIZONTALLY polarized and the X-axes are facing each other (i.e., normal usage position). The applied setting is "Set 1".
2. Range measurement with the MEDIUM IFA Antenna Boards—The antenna boards are VERTICALLY polarized and the X-axes are facing each other (i.e., normal usage position). The applied setting is "Set 1".
3. Range measurement with the MEDIUM IFA Antenna Boards—The antenna boards are VERTICALLY polarized and the X-axes are facing each other (i.e., normal usage position). The applied setting is "Set 2".
4. Range measurement with the MEDIUM IFA Antenna Boards—The antenna boards are VERTICALLY polarized and the X-axes are facing each other (i.e., normal usage position). The applied setting is "Set 3".
5. Range measurement with the MEDIUM IFA Antenna Boards—The antenna boards are VERTICALLY polarized and the boards are facing each other in their direction of maximum radiation. The applied setting is "Set 1".
6. Reference range measurement with two 434 MHz REFERENCE MONOPOLE (ANT-433-HETH from Linx Technologies) in VERTICAL polarization using the setting denoted by "Set 1".
7. Reference range measurement with two 434 MHz REFERENCE MONOPOLE (ANT-433-HETH from Linx Technologies) in VERTICAL polarization using the setting denoted by "Set 3".
8. Reference range measurement with a 434 MHz REFERENCE MONOPOLE (ANT-433-HETH from Linx Technologies) in HORIZONTAL polarization using the setting denoted by "Set 1".

The measurement results are summarized in Figure 15.

The indoor range test was not performed, due to the lack of a large enough building. But from the TX power and sensitivity data, an indoor range estimation can be given, if one assumes a propagation factor of 4.5, which is a typical value in normal office environments. Use the Silicon Labs' range calculator, which can be found here:

<http://www.silabs.com/support/pages/document-library.aspx?p=Wireless&f=EZRadioPRO&pn=Si4460>

Assuming a -5.3 dBi antenna gain (front direction, X axes facing) and the setting "Set 1" above (40 kbps, 1% PER, +8.8 dBm), the estimated indoor range is 83 m, as is shown in Figure 16. To the maximum antenna gain direction, the indoor range between two identical units is ~148 m.

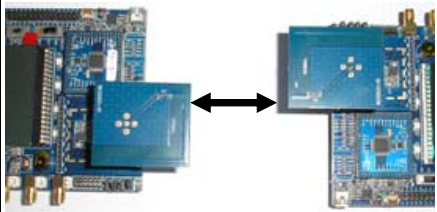
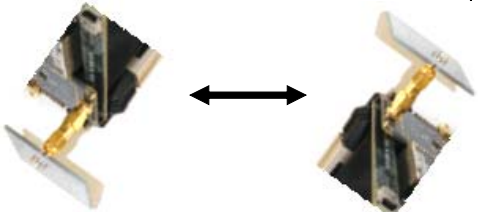
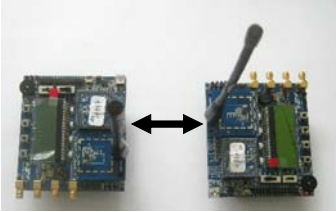
		Set1	10dBm	40kbps	+/-20kHz	GPS		Distance [m]		
		Set2	10dBm	100kbps	+/-50kHz	N	E			
		Set3	0dBm	2.4kbps	+/-2.4kHz	GPS		0.0		
						N	E			
F	Medium Printed IFA				Base	47.152880°	19.180930°	0.0		
Medium Printed IFA (WES0071)		H pol; Norm. direction						GPS		821.7
								N	E	
		1	Set1	10dBm	40kbps	+/-20kHz	47.158600°	19.174050°		
	V pol; Norm. direction						GPS		1151.2 945.1 1079.8	
							N	E		
	2	Set1	10dBm	40kbps	+/-20kHz	47.161950°	19.173590°			
	3	Set2	10dBm	100kbps	+/-50kHz	47.159940°	19.173970°			
	4	Set3	0dBm	2.4kbps	+/-2.4kHz	47.161250°	19.173690°			
	Max. direction: XZH 235°						GPS		1548.4	
							N	E		
	5	Set1	10dBm	40kbps	+/-20kHz	47.165710°	19.172970°			
ANT-433-HETH from LINX		V pol; Norm. direction						GPS		1778.7 1188.2
								N	E	
		6	Set1	10dBm	40kbps	+/-20kHz	47.167850°	19.172640°		
		7	Set3	0dBm	2.4kbps	+/-2.4kHz	47.162300°	19.17351		
	H pol; Norm. direction						GPS		1315.3	
							N	E		
	8	Set1	10dBm	40kbps	+/-20kHz	47.163520°	19.173330°			

Figure 15. Outdoor Range Test Results with Two Identical Medium Sized Printed IFA Boards Driven by Reduced Power 4460-PCE10D434 Pico Boards and WMB-930 Wireless Motherboards. Range Test Results with Reference Monopoles are Also Shown.

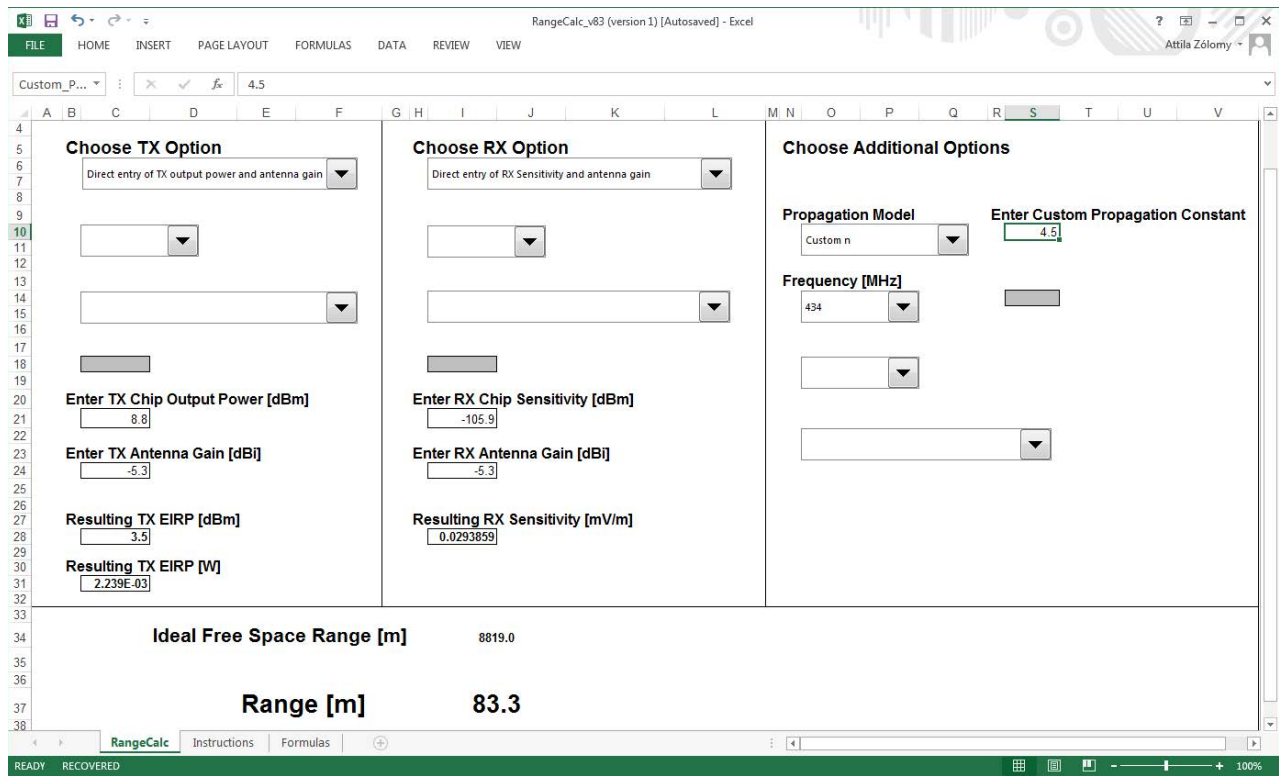


Figure 16. Indoor Range Estimation with Two Identical Medium Sized Printed IFA Boards Driven by Reduced Power 4460-PCE10D434 Pico Boards and WMB-930 Wireless Motherboards

3. Ceramic (Chip) Antenna (WES0072-01-ACM434D-01)

The selected chip antenna is Johanson Technology's 0433AT62A0020E type. For more information, go here:

<http://www.johansontechnology.com/datasheets/antennas/0433AT62A0020.pdf>

An external matching network (shown in Figure 17) is required at the antenna input.

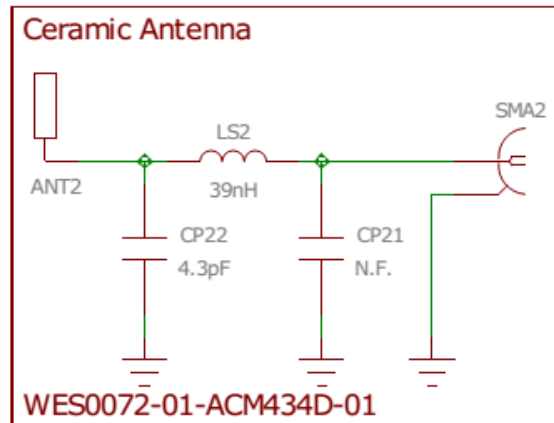


Figure 17. External Matching Network at 434 MHz for the 0433AT62A0020E Ceramic Antenna Type

The antenna board is shown in Figure 18.



Figure 18. Ceramic (Chip) Antenna

3.1. Antenna Impedance (WES0072-01-ACM434D-01)

The impedance measurement setup is shown in Figure 19. The antenna board is connected to the 4460-PCE10D434 Pico Board through a male-to-male SMA transition with the WMB-930 Wireless Motherboard driving the Pico Board.

During the impedance tuning and range test, the user's hand holds the motherboard. Typical hand position is shown in Figure 20.

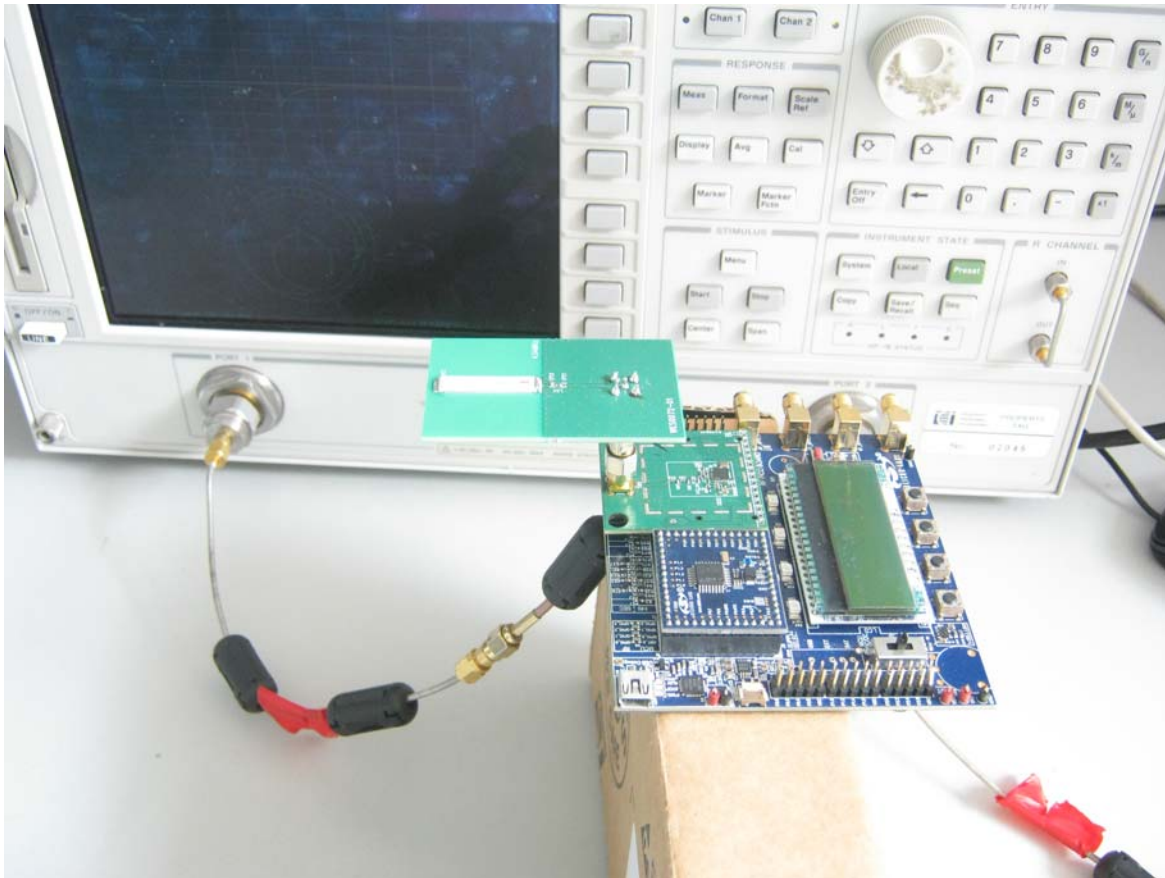


Figure 19. DUT in the Impedance Measurement Setup (WES0072 Ceramic Antenna)



Figure 20. Typical Hand Effect on the Main Board During Impedance and Range Measurement (Ceramic Antenna [WES0072] Board)

The measured impedance of the antenna with its external matching network is shown in Figure 21 (up to 1.5 GHz) with motherboard hand effect.

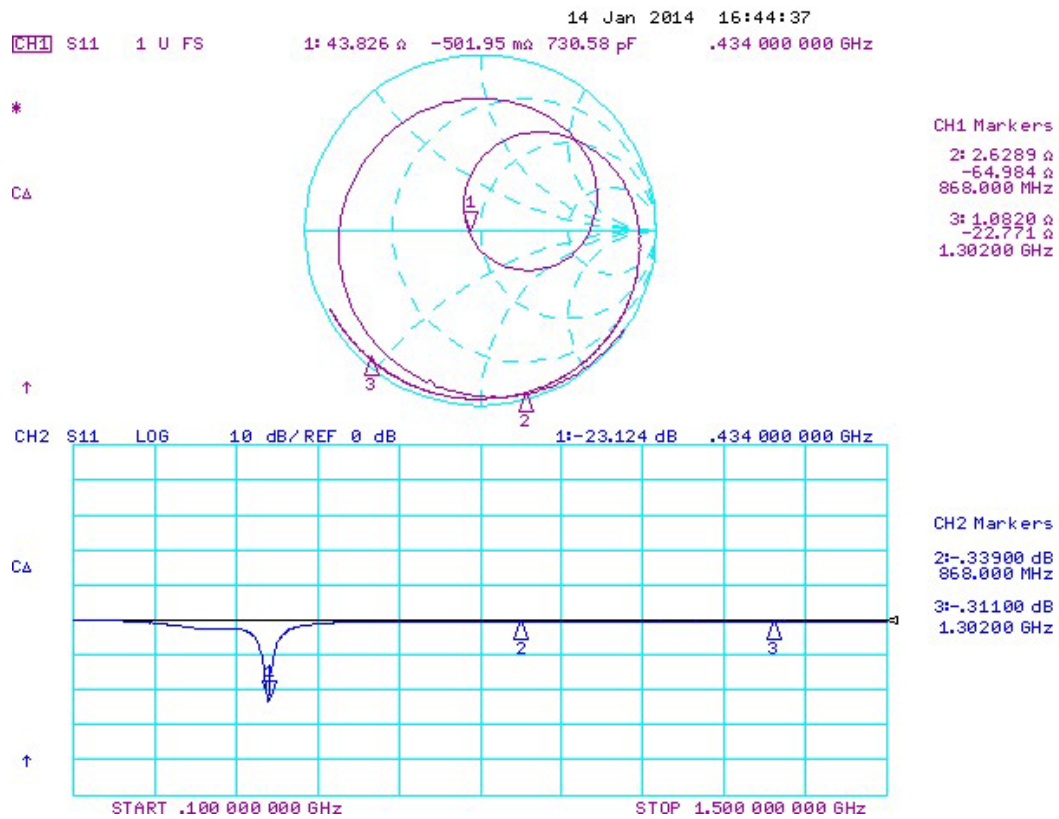


Figure 21. Measured Impedance up to 1.5 GHz with Hand Effect on the Main Board

3.2. Antenna Gain (WES0072-01-ACM434D-01)

The antenna gain is calculated both from the measured radiated power at the fundamental and from the delivered power to the antenna. In the radiation measurement, the 4455-PCE10D434 Pico Board is set to a reduced (~9 dBm) power level and the entire setup is fed by two AA batteries. The conducted SA measurement result of the 4455-PCE10D434 Pico Board in this reduced power state is shown in Figure 22. This method can be effectively applied because the S11 of the antenna is much better than -10 dB so the reflection loss is negligible.

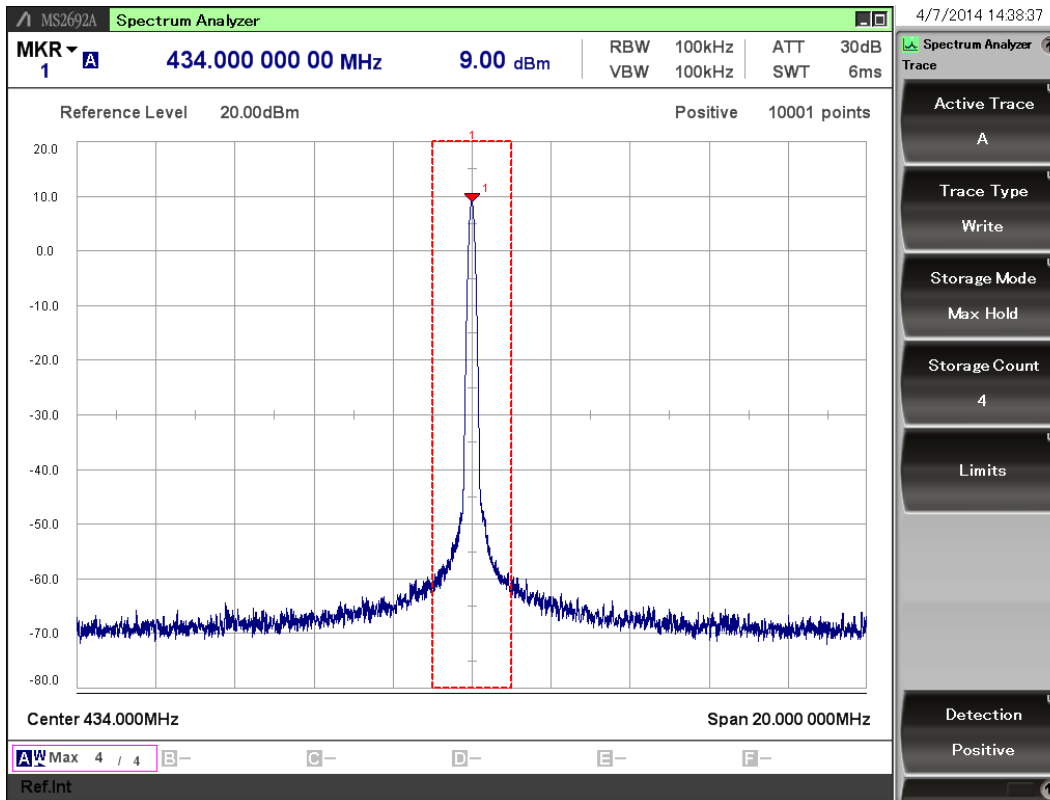


Figure 22. Conducted Measurement Result, 4455-PCE10D434 in a Reduced (+9 dBm) Power Level: the State is 0x4F and V_{DD} is ~2.9 V (Two AA Batteries)

The measured radiated power maximum is at the XZ cut (Table 3). It is around +7.1 dBm EIRP, so the maximum gain number is ~-1.9 dBi as shown in Figure 26.

3.3. Radiation Patterns (WES0072-01-ACM434D-01)

Radiation patterns of the ceramic antenna were measured in an antenna chamber with the 4455-PCE10D434 Pico Board connected through a male-to-male SMA transition and with the WMB-930 Wireless Motherboard driving the Pico Board. Figure 24—Figure 29 show the radiation patterns at the fundamental frequency in the XY, XZ, YZ cut, with both horizontal and vertical receiver antenna polarization. The rotator was stepped in five degrees to record the radiation pattern in 360 degrees.

The DUT, with coordinate system under the radiated measurements, is shown in Figure 23. In the XY cut the rotation starts from the X-axis, while in the XZ and YZ cuts rotation starts from the Z-axis.

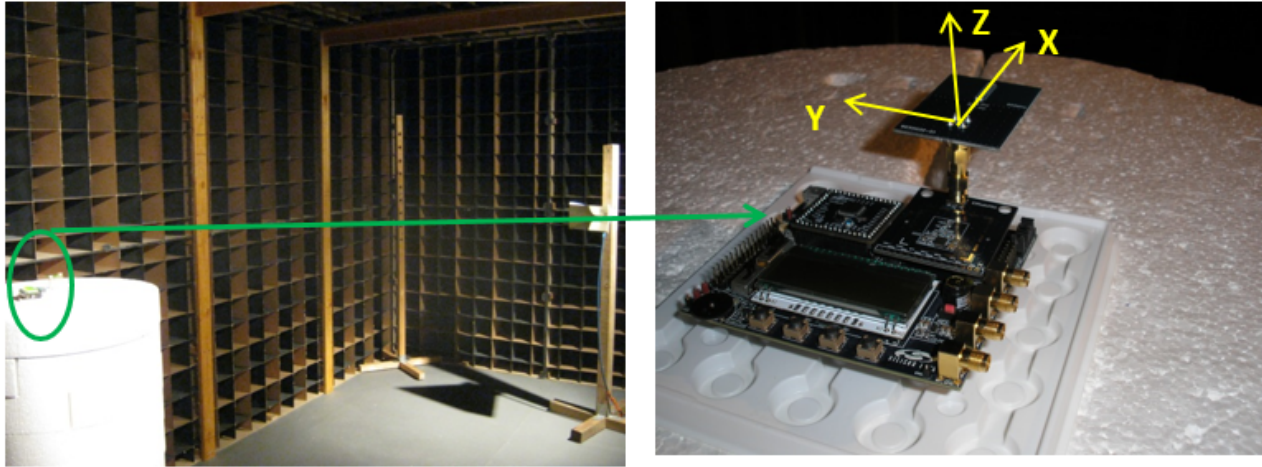


Figure 23. DUT in the Antenna Chamber

The measured radiation patterns (antenna gain in dBi) are shown in the following six figures (Figure 24–Figure 29).

**Radiation Pattern in dBi, 434MHz Ceramic
Antenna XYV**

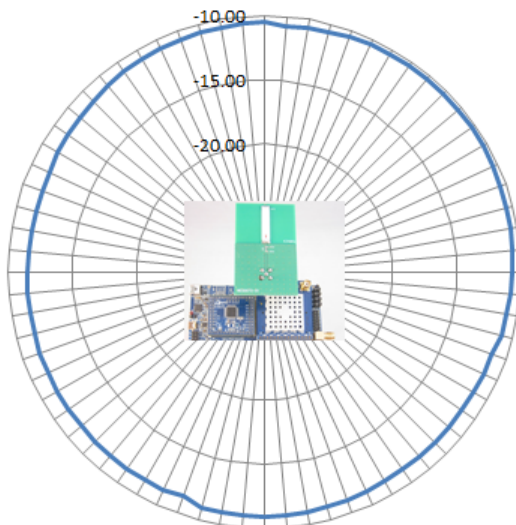


Figure 24. Radiation Pattern in the XY Cut with Vertical Receiver Antenna Polarization

**Radiation Pattern in dBi, 434MHz Ceramic
Antenna XYH**

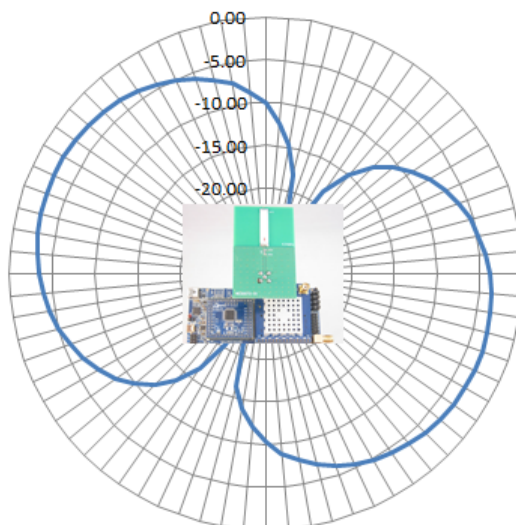


Figure 25. Radiation Pattern in the XY Cut with Horizontal Receiver Antenna Polarization

**Radiation Pattern in dBi, 434MHz Ceramic
Antenna XZV**

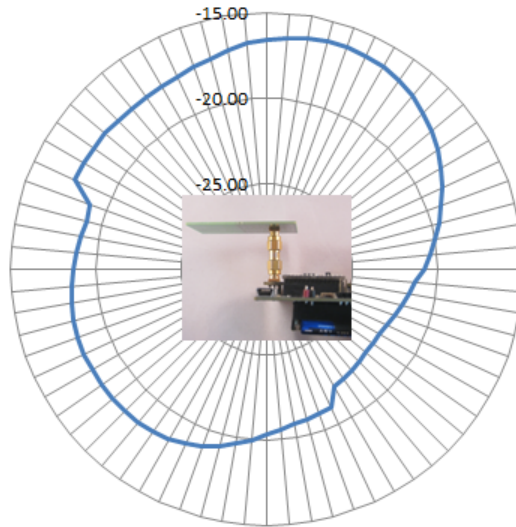


Figure 26. . Radiation Pattern in the XZ Cut with Vertical Receiver Antenna Polarization

**Radiation Pattern in dBi, 434MHz Ceramic
Antenna XZH**

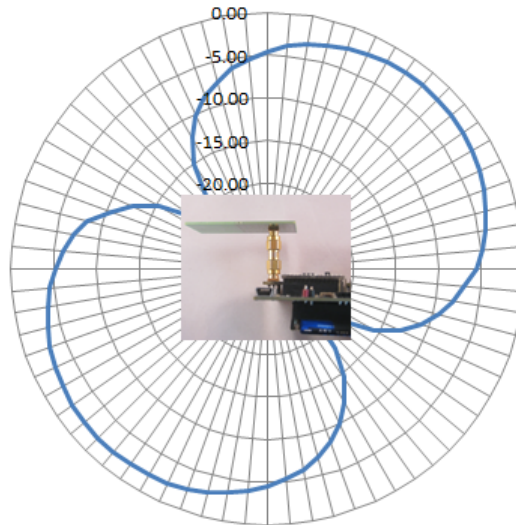


Figure 27. Radiation Pattern in the XZ Cut with Horizontal Receiver Antenna Polarization

**Radiation Pattern in dBi, 434MHz Ceramic
Antenna YZV**

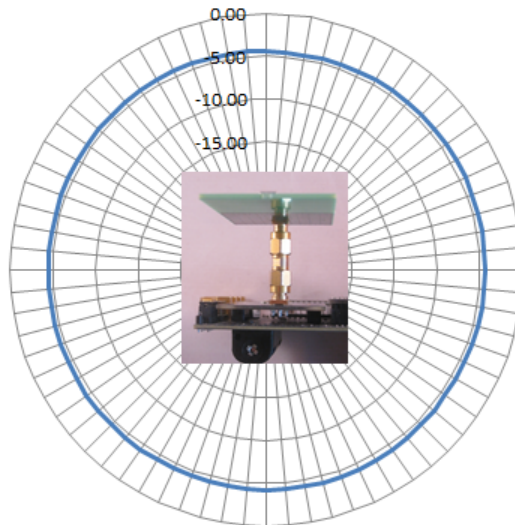


Figure 28. Radiation Pattern in the YZ Cut with Vertical Receiver Antenna Polarization

**Radiation Pattern in dBi, 434MHz Ceramic
Antenna YZH**

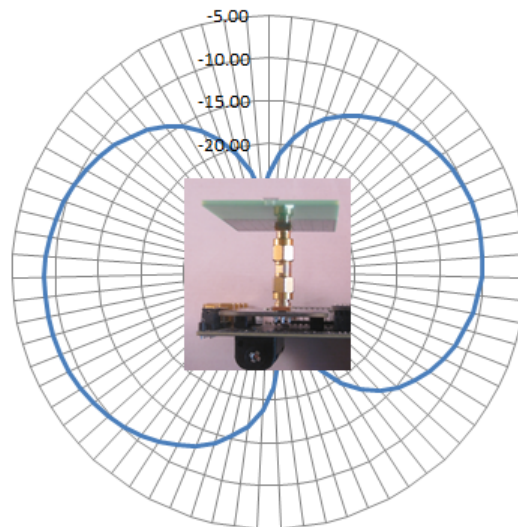


Figure 29. Radiation Pattern in the YZ Cut with Horizontal Receiver Antenna Polarization

3.4. Radiated Harmonics (WES0072-01-ACM434D-01)

The radiated harmonics of the ceramic antenna were also measured in an antenna chamber with the 4455-PCE10D434 Pico Board connected through a male-to-male SMA transition and with the WMB-930 Wireless Motherboard driving the Pico Board. The 4455-PCE10D434 Pico Board is set to a power state of 0x4F and a V_{DD} of ~2.9 V (two AA batteries) to deliver ~+9 dBm, as shown in Figure 22. The maximum radiated power levels, up to the 10th harmonic, were measured in the XY, XZ, and YZ cut, with both horizontal and vertical polarized receiver antenna. The results are shown in the following EIRP table (Table 3) together with the corresponding standard limits.

The Antenna is ETSI compliant with large margin.

Table 3. Radiated harmonics, Ceramic Antenna board Connected to the Reduced Power (~+9 dBm) 4455-PCE10D434 Output, Driven by the WMB-930 Wireless Motherboard

Cut.	Pol.	Freq.	f [MHz]	ETSI limit in EIRP [dBm]	Measured radiated power in EIRP [dBm]	Margin [dB]
XY	V	Fund.	434	12.14	-1.29	13.4
XY	V	2 nd	868	-33.88	-69.41	35.5
XY	V	3 rd	1302	-27.86	-67.73	39.9
XY	V	4 th	1736	-27.86	-51.20	23.3
XY	V	5 th	2170	-27.86	-44.04	16.2
XY	V	6 th	2604	-27.86	-44.93	17.1
XY	V	7 th	3038	-27.86	-45.40	17.5
XY	V	8 th	3472	-27.86	-47.28	19.4
XY	V	9 th	3906	-27.86	-47.46	19.6
XY	V	10 th	4340	-27.86	-45.08	17.2
XY	H	Fund.	434	12.14	6.26	5.9
XY	H	2 nd	868	-33.88	-72.92	39.0
XY	H	3 rd	1302	-27.86	-69.92	42.1
XY	H	4 th	1736	-27.86	-55.77	27.9
XY	H	5 th	2170	-27.86	-49.62	21.8
XY	H	6 th	2604	-27.86	-46.23	18.4
XY	H	7 th	3038	-27.86	-47.69	19.8
XY	H	8 th	3472	-27.86	-49.69	21.8
XY	H	9 th	3906	-27.86	-46.08	18.2

Table 3. Radiated harmonics, Ceramic Antenna board Connected to the Reduced Power (~+9 dBm) 4455-PCE10D434 Output, Driven by the WMB-930 Wireless Motherboard(Continued)

Cut.	Pol.	Freq.	f [MHz]	ETSI limit in EIRP [dBm]	Measured radiated power in EIRP [dBm]	Margin [dB]
XY	H	10 th	4340	-27.86	-45.18	17.3
XZ	V	Fund.	434	12.14	-7.17	19.3
XZ	V	2 nd	868	-33.88	-71.24	37.4
XZ	V	3 rd	1302	-27.86	-65.96	38.1
XZ	V	4 th	1736	-27.86	-52.56	24.7
XZ	V	5 th	2170	-27.86	-43.29	15.4
XZ	V	6 th	2604	-27.86	-41.11	13.3
XZ	V	7 th	3038	-27.86	-43.52	15.7
XZ	V	8 th	3472	-27.86	-49.26	21.4
XZ	V	9 th	3906	-27.86	-47.42	19.6
XZ	V	10 th	4340	-27.86	-42.13	14.3
XZ	H	Fund.	434	12.14	7.05	5.1
XZ	H	2 nd	868	-33.88	-71.47	37.6
XZ	H	3 rd	1302	-27.86	-69.61	41.8
XZ	H	4 th	1736	-27.86	-53.79	25.9
XZ	H	5 th	2170	-27.86	-43.90	16.0
XZ	H	6 th	2604	-27.86	-38.76	10.9
XZ	H	7 th	3038	-27.86	-45.13	17.3
XZ	H	8 th	3472	-27.86	-47.59	19.7
XZ	H	9 th	3906	-27.86	-49.94	22.1
XZ	H	10 th	4340	-27.86	-43.76	15.9
YZ	V	Fund.	434	12.14	4.78	7.4
YZ	V	2 nd	868	-33.88	-72.94	39.1
YZ	V	3 rd	1302	-27.86	-66.51	38.7

Table 3. Radiated harmonics, Ceramic Antenna board Connected to the Reduced Power (~+9 dBm) 4455-PCE10D434 Output, Driven by the WMB-930 Wireless Motherboard(Continued)

Cut.	Pol.	Freq.	f [MHz]	ETSI limit in EIRP [dBm]	Measured radiated power in EIRP [dBm]	Margin [dB]
YZ	V	4 th	1736	-27.86	-52.97	25.1
YZ	V	5 th	2170	-27.86	-45.45	17.6
YZ	V	6 th	2604	-27.86	-44.40	16.5
YZ	V	7 th	3038	-27.86	-44.17	16.3
YZ	V	8 th	3472	-27.86	-45.28	17.4
YZ	V	9 th	3906	-27.86	-47.81	20.0
YZ	V	10 th	4340	-27.86	-43.26	15.4
YZ	H	Fund.	434	12.14	0.40	11.7
YZ	H	2 nd	868	-33.88	-71.93	38.1
YZ	H	3 rd	1302	-27.86	-69.78	41.9
YZ	H	4 th	1736	-27.86	-53.19	25.3
YZ	H	5 th	2170	-27.86	-45.42	17.6
YZ	H	6 th	2604	-27.86	-37.49	9.6
YZ	H	7 th	3038	-27.86	-46.60	18.7
YZ	H	8 th	3472	-27.86	-48.89	21.0
YZ	H	9 th	3906	-27.86	-47.41	19.6
YZ	H	10 th	4340	-27.86	-42.78	14.9

3.5. Range Test (WES0072-01-ACM434D-01)

The available range was measured using the Range Test Demo. This application is supplied with the standard development kits for EZRadioPRO®. The target of this measurement is to find the distance between the transceivers where the one-directional PER (Packet Error Rate, number of lost packets) is not more than 1% at each side with ten byte long packets. The GPS coordinates have been recorded for each spot. The distance between the spots has been measured using Google Maps, and results are shown in meters. The range was tested with two identical units held in hands, as shown in Figure 20. Each unit comprises a WMB-930 Wireless Motherboard, a 4460-PCE10D434 Pico Board, and the DUT (as shown in Figure 20). In some tests the 4460-PCE10D434 Pico Board is set to +10 dBm TX power state, while in other tests it is set to 0 dBm.

The range was tested in a flat land area without obstacles.

During the range tests, the following settings were used:

- Set 1: Txpow=10 dBm (~8.8 dBm @ 3 V V_{DD}), 40 kbps, 25 kHz dev., RXBW=82.64 kHz (sens ~-105.5 dBm)
- Set 2: Txpow=10 dBm (~8.8 dBm @ 3 V V_{DD}), 100 kbps, 50 kHz dev., RXBW=206.12 kHz (sens ~-100.7 dBm)
- Set 3: Txpow=0 dBm, 2.4 kbps, 2.4 kHz dev., RXBW=25.77 kHz (sens ~-115.9 dBm)

Using the above settings (Set 1, Set 2, and Set 3) the following range tests are done here:

1. Range measurement with the CERAMIC Antenna Boards—The antenna boards are HORIZONTALLY polarized and the X-axes are facing each other (i.e., normal usage position). The applied setting is "Set 1".
2. Range measurement with the CERAMIC Antenna Boards—The antenna boards are VERTICALLY polarized and the X-axes are facing each other (i.e., normal usage position). The applied setting is "Set 1".
3. Range measurement with the CERAMIC Antenna Boards—The antenna boards are VERTICALLY polarized and the X-axes are facing each other (i.e., normal usage position). The applied setting is "Set 2".
4. Range measurement with the CERAMIC Antenna Boards—The antenna boards are VERTICALLY polarized and the X-axes are facing each other (i.e., normal usage position). The applied setting is "Set 3".
5. Range measurement with the CERAMIC Antenna Boards—The antenna boards are VERTICALLY polarized and the boards are facing each other in their direction of maximum radiation. The applied setting is "Set 1".
6. Reference range measurement with two 434 MHz REFERENCE MONOPOLE (ANT-433-HETH from Linx Technologies) in VERTICAL polarization using the setting denoted by "Set 1".
7. Reference range measurement with two 434 MHz REFERENCE MONOPOLE (ANT-433-HETH from Linx Technologies) in VERTICAL polarization using the setting denoted by "Set 3".
8. Reference range measurement with a 434 MHz REFERENCE MONOPOLE (ANT-433-HETH from Linx Technologies) in HORIZONTAL polarization using the setting denoted by "Set 1".

The measurement results are summarized in Figure 30.

The indoor range was not measured, due to the lack of a large enough building. But from the TX power and sensitivity data, an estimation can be given if one assumes an indoor propagation factor of 4.5, which is a typical value in normal office environments. Use the Silicon Labs' range calculator, which can be found on this webpage:

<http://www.silabs.com/support/pages/document-library.aspx?p=Wireless&f=EZRadioPRO&pn=Si4460>

Assuming a -10 dBi antenna gain (front direction, X-axes facing) and the setting "Set 1" (40 kbps, 1% PER, +8.8 dBm), the estimated indoor range is 52 m, as it is shown in Figure 31.

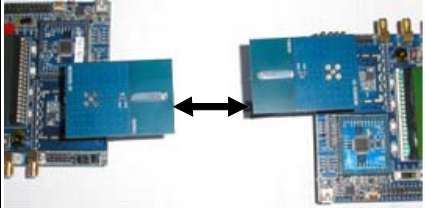
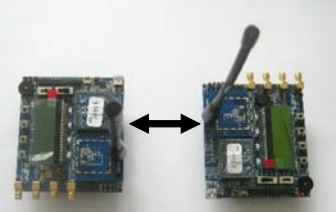
		Set1	10dBm	40kbps	+/-20kHz			Distance [m]		
		Set2	10dBm	100kbps	+/-50kHz					
		Set3	0dBm	2.4kbps	+/-2.4kHz	GPS				
						N	E			
F	Ceramic (Chip) Antenna				Base	47.152880°	19.180930°	0.0		
Antenna (WES0072)		H pol; Norm. direction						GPS		461.8
								N	E	
		1	Set1	10dBm	40kbps	+/-20kHz	47.155540°	19.176240°		
	V pol; Norm. direction						GPS		838.3 554.1 721.3	
							N	E		
	2	Set1	10dBm	40kbps	+/-20kHz	47.158840°	19.174140°			
	3	Set2	10dBm	100kbps	+/-50kHz	47.156180°	19.175440°			
	4	Set3	0dBm	2.4kbps	+/-2.4kHz	47.157570°	19.174340°			
Max. direction: XZH 40°						GPS		1308.6		
						N	E			
5	Set1	10dBm	40kbps	+/-20kHz	47.163450°	19.173320°				
ANT-433-HETH from LINX		V pol; Norm. direction						GPS		1778.7 1188.2
								N	E	
		6	Set1	10dBm	40kbps	+/-20kHz	47.167850°	19.172640°		
	7	Set3	0dBm	2.4kbps	+/-2.4kHz	47.162300°	19.17351°			
	H pol; Norm. direction						GPS		1315.3	
						N	E			
8	Set1	10dBm	40kbps	+/-20kHz	47.163520°	19.173330°				

Figure 30. Outdoor Range Test Results with Two Identical Ceramic Antenna Boards Driven by Reduced Power 4460-PCE10D434 Pico Boards and WMB-930 Wireless Motherboards. Range Test Results with Reference Monopoles are Also Shown.

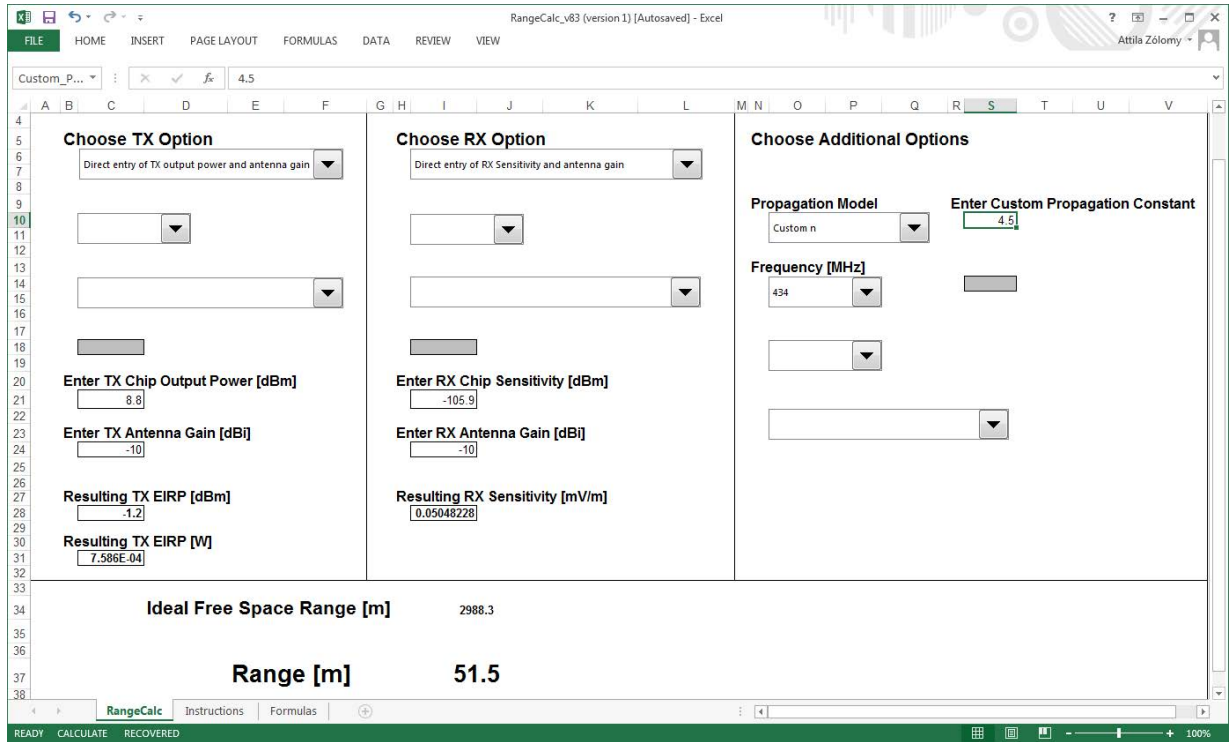


Figure 31. Indoor Range Estimation with Two Identical Ceramic Antenna Boards Driven by Reduced Power 4460-PCE10D434 Pico Boards and WMB-930 Wireless Motherboards

4. Printed BIFA (WES0073-01-APB434D-01)

For the Printed BIFA Antenna, an external matching network (shown in Figure 32) is required at the antenna input.

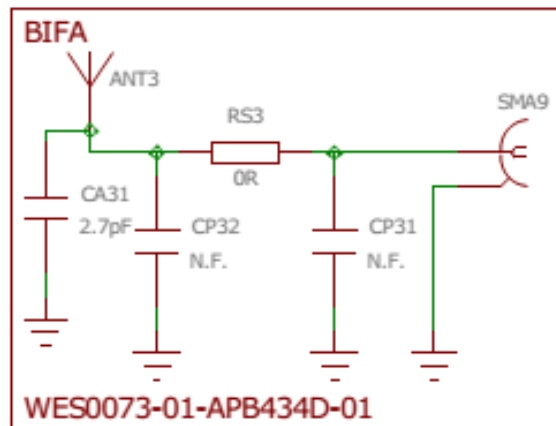


Figure 32. External Matching Network at 434 MHz for the BIFA Antenna

The antenna is shown in Figure 33.



Figure 33. Printed BIFA Antenna

4.1. Antenna Impedance (WES0073-01-APB434D-01)

The impedance measurement setup is shown in Figure 34. The antenna board is connected to the 4455-PCE10D434 Pico Board through a male-to-male SMA transition with the WMB-930 Wireless Motherboard driving the Pico Board.

During the range test, the user's hand holds the motherboard. A typical hand position is shown in Figure 35.

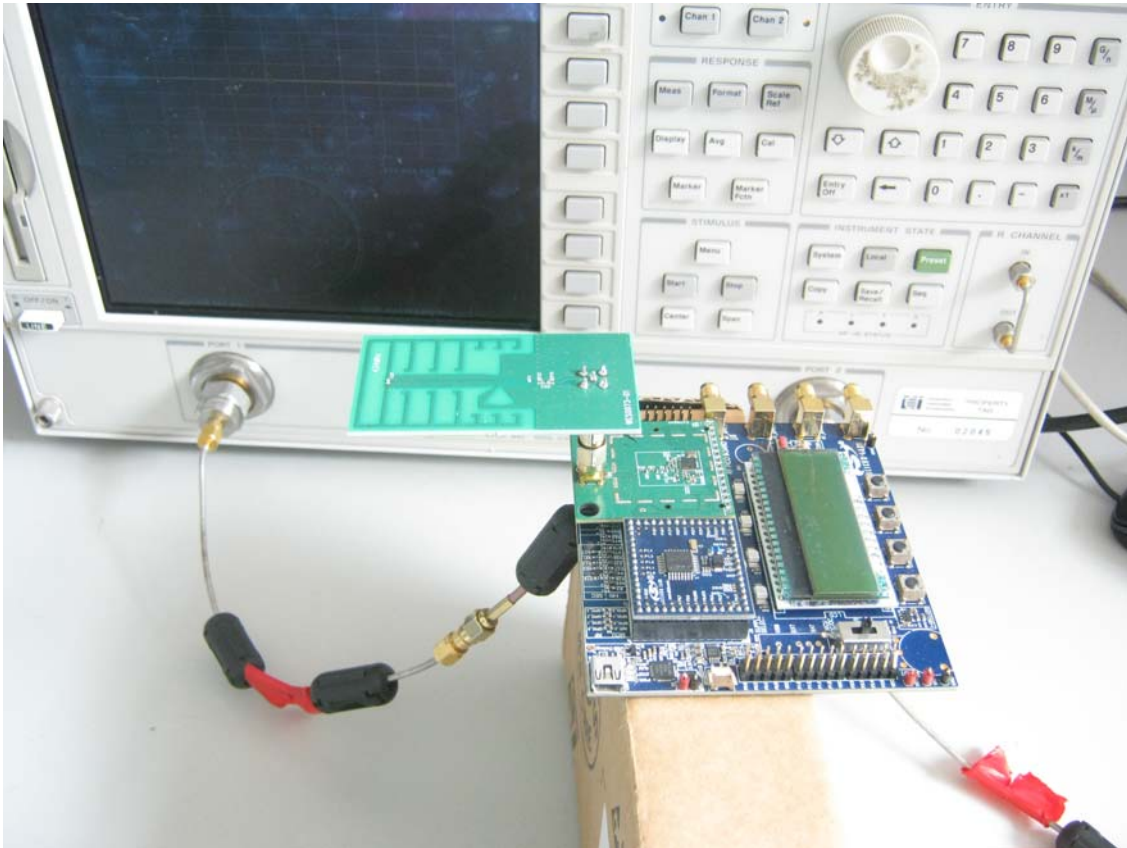


Figure 34. DUT in the Impedance Measurement Setup (BIFA Antenna Board [WES0073])



Figure 35. Typical Hand Effect on the Main Board During Impedance and Range Measurement (BIFA Antenna Board [WES0073])

The measured impedance of the antenna with its external matching network is shown in Figure 36 (up to 1.5 GHz) with motherboard hand effect.

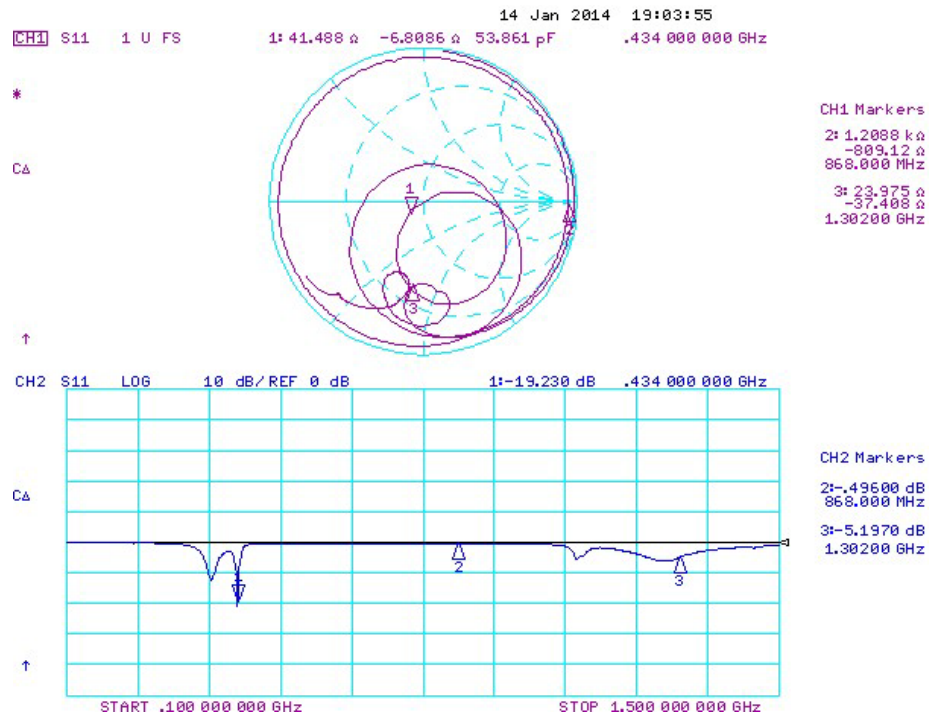


Figure 36. Measured Impedance up to 1.5 GHz with Hand Effect on the Main Board

4.2. Antenna Gain (WES0073-01-APB434D-01)

The antenna gain is calculated from the measured radiated power at the fundamental and from the delivered power to the antenna. In the radiation measurement, the P4455-PCE10D434 Pico Board is set to a reduced (~+9 dBm) power level and the entire setup is fed by two AA batteries. The conducted SA measurement result of the 4455-PCE10D434 Pico Board in this reduced power state is shown in Figure 37. This method can be effectively applied because the S11 of the antenna is much better than -10 dB, so the reflection loss is negligible.

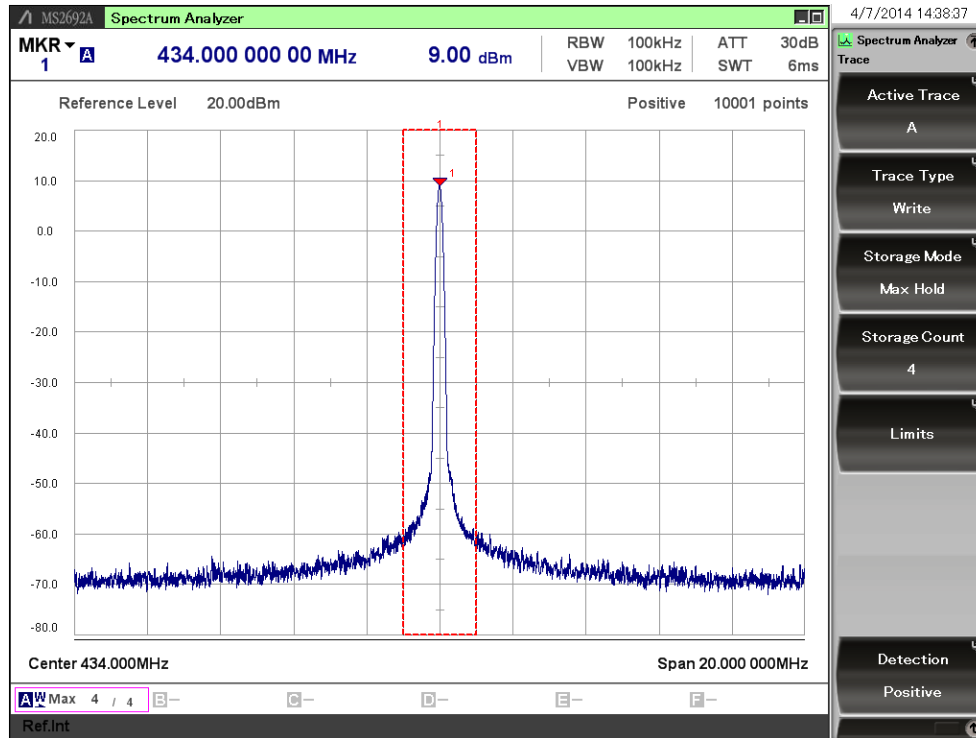


Figure 37. Conducted Measurement Result, 4455-PCE10D434 at Reduced Power Level: the State is 0x4F and V_{DD} is ~2.9 V (Two AA Batteries)

The measured radiated power maximum is at the XY cut (Table 4). It is around +3.2 dBm EIRP, so the maximum gain number is ~-5.8 dBi, as shown in Figure 41. The maximum gain of the BIFA is significantly lower than that of some single-ended, smaller antennas (e.g., Wire Helical WES0072) in this report. The reason is that unlike other single-ended antennas, the BIFA is a real differential antenna (fed through the printed BALUN at the input) and thus, cannot utilize the large ground supplied by the SMA male-to-male transition + pico board + motherboard configuration. But in real applications, where the form factor is close to that of the antenna board only, the BIFA antenna gain will remain nearly the same, while the gain of most other single-ended antennas shown in this document will degrade significantly.

4.3. Radiation Patterns (WES0073-01-APB434D-01)

Radiation patterns of the printed BIFA antenna were measured in an antenna chamber using the 4455-PCE10D434 Pico Board connected through a male-to-male SMA transition with the WMB-930 Wireless Motherboard driving the Pico Board. Figure 39—Figure 44 show the radiation patterns at the fundamental frequency in the XY, XZ, and YZ cut, with both horizontal and vertical receiver antenna polarization. The rotator was stepped in five degrees to record the radiation pattern in 360 degrees.

The DUT with coordinate system under the radiated measurements is shown in Figure 38. In the XY cut the rotation starts from the X-axis, while in the XZ and YZ cuts rotation starts from the Z-axis.

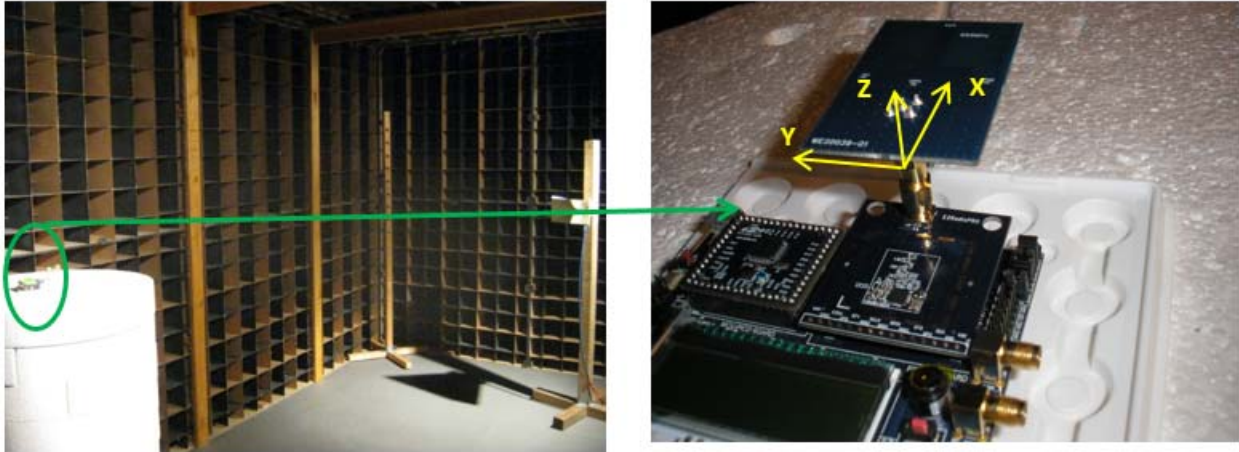


Figure 38. DUT in the Antenna Chamber

The measured radiation patterns (antenna gain in dBi) are shown in the following six figures (Figure 39–Figure 44).

Radiation Pattern in dBi, 434MHz BIFA XYV

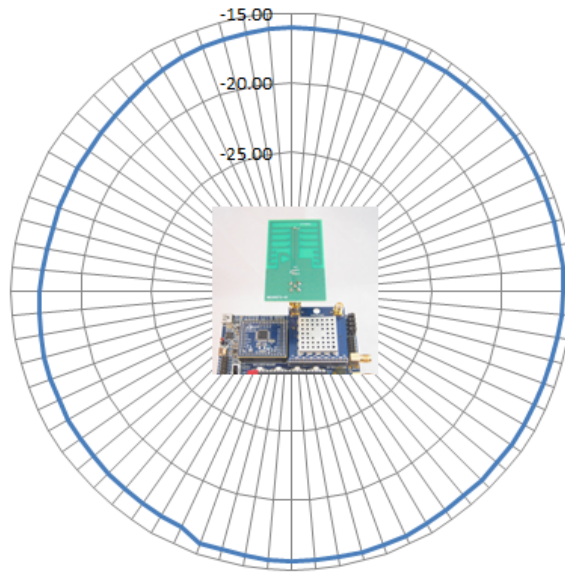


Figure 39. Radiation Pattern in the XY Cut with Vertical Receiver Antenna Polarization

Radiation Pattern in dBi, 434MHz BIFA XYH

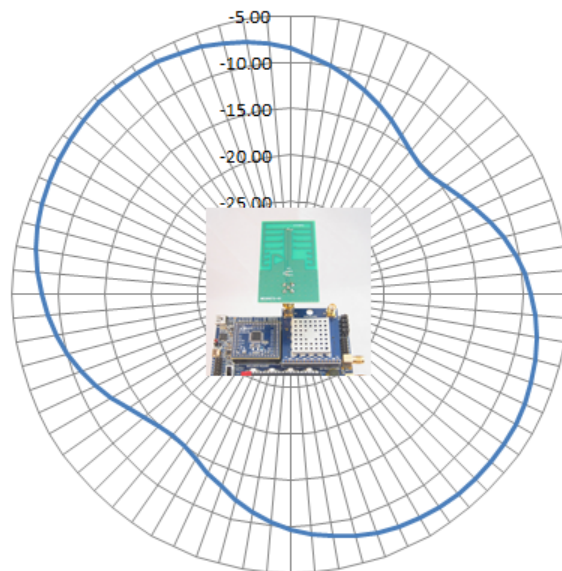


Figure 40. Radiation Pattern in the XY Cut with Horizontal Receiver Antenna Polarization

Radiation Pattern in dBi, 434MHz BIFA XZV

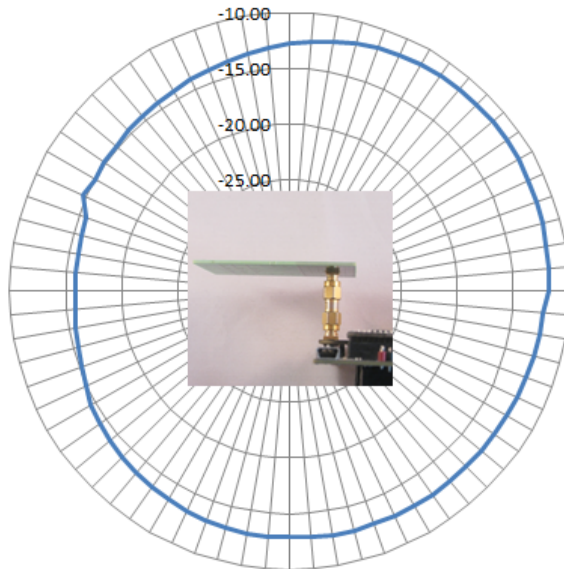


Figure 41. Radiation Pattern in the XZ Cut with Vertical Receiver Antenna Polarization

Radiation Pattern in dBi, 434MHz BIFA XZH

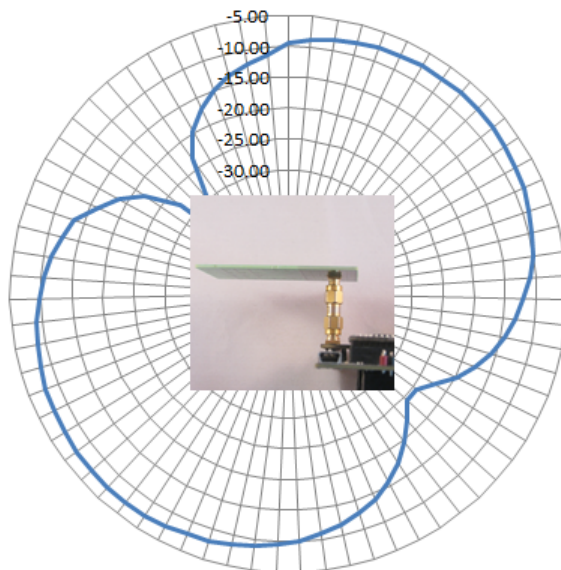


Figure 42. Radiation Pattern in the XZ Cut with Horizontal Receiver Antenna Polarization

Radiation Pattern in dBi, 434MHz BIFA YZV

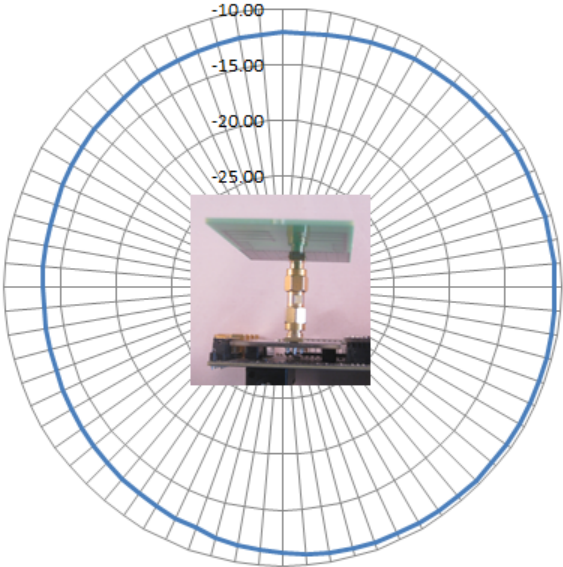


Figure 43. Radiation Pattern in the YZ Cut with Vertical Receiver Antenna Polarization

Radiation Pattern in dBi, 434MHz BIFA YZH

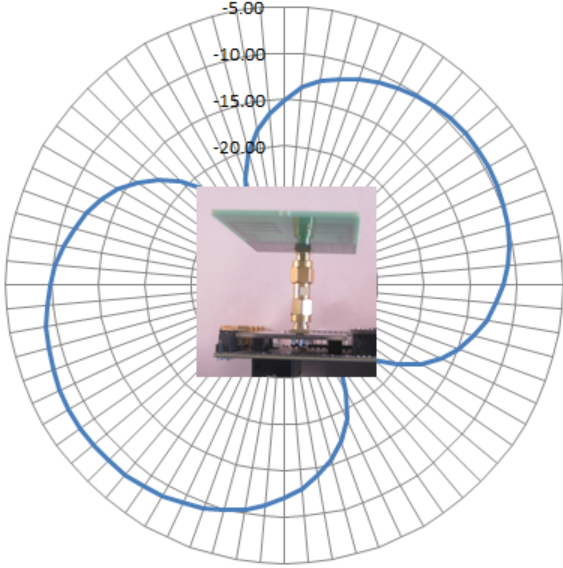


Figure 44. Radiation Pattern in the YZ Cut with Horizontal Receiver Antenna Polarization

4.4. Radiated Harmonics (WES0073-01-APB434D-01)

The radiated harmonics of the BIFA antenna were also measured in an antenna chamber using the 4455-PCE10D434 Pico Board connected through a male-to-male SMA transition with the WMB-930 Wireless Motherboard driving the Pico Board. The 4455-PCE10D434 Pico Board is set to a power state of 0x4F and a V_{DD} of ~2.9 V (two AA batteries) to deliver ~+9 dBm, as shown in Figure 37. The maximum radiated power levels, up to the 10th harmonic, were measured in the XY, XZ and YZ cut, with both horizontal and vertical polarized receiver antenna. Results are shown in the following EIRP table (Table 4) together with the corresponding standard limits.

The BIFA antenna driven by the Si4455/60 10 dBm class E match complies with the ETSI harmonic regulations.

Table 4. Radiated Harmonics, BIFA Antenna Board Driven by the 4455-PCE10D434 Pico Board in Reduced Power (~+9 dBm) State and by the WMB-930 Wireless Motherboard

Cut.	Pol.	Freq.	f [MHz]	ETSI limit in EIRP [dBm]	Measured radiated power in EIRP [dBm]	Margin [dB]
XY	V	Fund.	434	12.14	-6.51	18.6
XY	V	2 nd	868	-33.88	-68.77	34.9
XY	V	3 rd	1302	-27.86	-66.99	39.1
XY	V	4 th	1736	-27.86	-51.40	23.5
XY	V	5 th	2170	-27.86	-45.54	17.7
XY	V	6 th	2604	-27.86	-45.24	17.4
XY	V	7 th	3038	-27.86	-46.62	18.8
XY	V	8 th	3472	-27.86	-48.55	20.7
XY	V	9 th	3906	-27.86	-47.11	19.3
XY	V	10 th	4340	-27.86	-44.89	17.0
XY	H	Fund.	434	12.14	3.24	8.9
XY	H	2 nd	868	-33.88	-70.20	36.3
XY	H	3 rd	1302	-27.86	-67.59	39.7
XY	H	4 th	1736	-27.86	-54.34	26.5
XY	H	5 th	2170	-27.86	-51.03	23.2
XY	H	6 th	2604	-27.86	-42.41	14.6
XY	H	7 th	3038	-27.86	-47.87	20.0
XY	H	8 th	3472	-27.86	-48.61	20.7
XY	H	9 th	3906	-27.86	-46.86	19.0
XY	H	10 th	4340	-27.86	-43.17	15.3

Table 4. Radiated Harmonics, BIFA Antenna Board Driven by the 4455-PCE10D434 Pico Board in Reduced Power (~+9 dBm) State and by the WMB-930 Wireless Motherboard(Continued)

Cut.	Pol.	Freq.	f [MHz]	ETSI limit in EIRP [dBm]	Measured radiated power in EIRP [dBm]	Margin [dB]
XZ	V	Fund.	434	12.14	-2.34	14.5
XZ	V	2 nd	868	-33.88	-69.51	35.6
XZ	V	3 rd	1302	-27.86	-66.83	39.0
XZ	V	4 th	1736	-27.86	-52.30	24.4
XZ	V	5 th	2170	-27.86	-46.49	18.6
XZ	V	6 th	2604	-27.86	-40.69	12.8
XZ	V	7 th	3038	-27.86	-45.36	17.5
XZ	V	8 th	3472	-27.86	-48.84	21.0
XZ	V	9 th	3906	-27.86	-47.25	19.4
XZ	V	10 th	4340	-27.86	-42.40	14.5
XZ	H	Fund.	434	12.14	1.83	10.3
XZ	H	2 nd	868	-33.88	-70.26	36.4
XZ	H	3 rd	1302	-27.86	-67.93	40.1
XZ	H	4 th	1736	-27.86	-53.74	25.9
XZ	H	5 th	2170	-27.86	-45.13	17.3
XZ	H	6 th	2604	-27.86	-40.69	12.8
XZ	H	7 th	3038	-27.86	-43.28	15.4
XZ	H	8 th	3472	-27.86	-47.30	19.4
XZ	H	9 th	3906	-27.86	-49.83	22.0
XZ	H	10 th	4340	-27.86	-45.63	17.8
YZ	V	Fund.	434	12.14	0.90	11.2
YZ	V	2 nd	868	-33.88	-68.26	34.4
YZ	V	3 rd	1302	-27.86	-63.82	36.0
YZ	V	4 th	1736	-27.86	-53.44	25.6

Table 4. Radiated Harmonics, BIFA Antenna Board Driven by the 4455-PCE10D434 Pico Board in Reduced Power (~+9 dBm) State and by the WMB-930 Wireless Motherboard(Continued)

Cut.	Pol.	Freq.	f [MHz]	ETSI limit in EIRP [dBm]	Measured radiated power in EIRP [dBm]	Margin [dB]
YZ	V	5 th	2170	-27.86	-47.75	19.9
YZ	V	6 th	2604	-27.86	-41.03	13.2
YZ	V	7 th	3038	-27.86	-44.23	16.4
YZ	V	8 th	3472	-27.86	-45.87	18.0
YZ	V	9 th	3906	-27.86	-49.14	21.3
YZ	V	10 th	4340	-27.86	-44.45	16.6
YZ	H	Fund.	434	12.14	-1.46	13.6
YZ	H	2 nd	868	-33.88	-71.46	37.6
YZ	H	3 rd	1302	-27.86	-67.98	40.1
YZ	H	4 th	1736	-27.86	-51.64	23.8
YZ	H	5 th	2170	-27.86	-46.45	18.6
YZ	H	6 th	2604	-27.86	-39.26	11.4
YZ	H	7 th	3038	-27.86	-49.14	21.3
YZ	H	8 th	3472	-27.86	-49.56	21.7
YZ	H	9 th	3906	-27.86	-51.07	23.2
YZ	H	10 th	4340	-27.86	-44.72	16.9

4.5. Range Test (WES0073-01-APB434D-01)

The available range was measured using the Range Test Demo. This application is supplied with the standard development kits for EZRadioPRO®. The target of this measurement is to find the distance between the transceivers where the unidirectional PER (Packet Error Rate, number of lost packets) is not more than 1% at each side with ten byte long packets. The GPS coordinates have been recorded for each spot. The distance between the spots has been measured using Google Maps, and results are shown in meters. The range was tested with two identical units held in hands, as shown in Figure 35. Each unit comprises a WMB-930 Wireless Motherboard, a 4460-PCE10D434 Pico Board, and the DUT (as shown in Figure 35). During the tests, the Pico Board is set to the normal (+ 10 dBm) or reduced power state (0 dBm).

The nominal +10 dBm power setting (state of 0x2D) is valid at 3.3 V V_{DD} only. At 3 V V_{DD} , supplied by the two AA batteries the power level is lower, around +8.8 dBm. At the nominal 0 dBm setting (state of 0x07) the power decrease is negligible at 3 V V_{DD} .

The range was tested in a flat land area without obstacles.

During the range test, the following settings have been used:

- Set 1: Txpow=10 dBm (~8.8 dBm @ 3 V V_{DD}), 40 kbps, 20 kHz dev., RXBW=82.64 kHz (sens ~-105.5 dBm)
- Set 2: Txpow=10 dBm (~8.8 dBm @ 3 V V_{DD}), 100 kbps, 50 kHz dev., RXBW=206.12 kHz (sens ~-100.7 dBm)
- Set 3: Txpow=0 dBm, 2.4 kbps, 2.4 kHz dev., RXBW=25.77 kHz (sens ~-115.9 dBm)

Two outdoor range tests were performed.

Using the above settings (Set 1, Set 2, and Set 3) the following range tests are done here:

1. Range measurement with the BIFA Antenna Boards—The antenna boards are HORIZONTALLY polarized and the X-axes are facing each other (i.e., normal usage position). The applied setting is "Set 1".
2. Range measurement with the BIFA Antenna Boards—The antenna boards are VERTICALLY polarized and the X-axes are facing each other (i.e., normal usage position). The applied setting is "Set 1".
3. Range measurement with the BIFA Antenna Boards—The antenna boards are VERTICALLY polarized and the X-axes are facing each other (i.e., normal usage position). The applied setting is "Set 2".
4. Range measurement with the BIFA Antenna Boards—The antenna boards are VERTICALLY polarized and the X-axes are facing each other (i.e., normal usage position). The applied setting is "Set 3".
5. Range measurement with the BIFA Antenna Boards—The antenna boards are VERTICALLY polarized and the boards are facing each other in their direction of maximum radiation. The applied setting is "Set 1".
6. Reference range measurement with two 434 MHz REFERENCE MONOPOLE (ANT-433-HETH from Linx Technologies) in VERTICAL polarization using the setting denoted by "Set 1".
7. Reference range measurement with two 434 MHz REFERENCE MONOPOLE (ANT-433-HETH from Linx Technologies) in VERTICAL polarization using the setting denoted by "Set 3".
8. Reference range measurement with a 434 MHz REFERENCE MONOPOLE (ANT-433-HETH from Linx Technologies) in HORIZONTAL polarization using the setting denoted by "Set 1".

The measurement results are summarized in Figure 45.

The indoor range test is not performed, due to the lack of a large enough building. But from the TX power and sensitivity data, an indoor range estimation can be given if one assumes a propagation factor of 4.5, which is a typical value in normal office environments. Use the Silicon Labs' range calculator, which can be found here:

<http://www.silabs.com/support/pages/document-library.aspx?p=Wireless&f=EZRadioPRO&pn=Si4460>

Assuming -8.5 dBi antenna gain (front direction, X-axes facing) and the setting "Set 1" (40 kbps, 1% PER, +8.8 dBm), the estimated indoor range is 60 m, as shown in Figure 46. To the maximum antenna gain direction, the indoor range between two identical units is ~79 m.

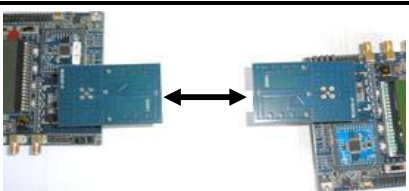
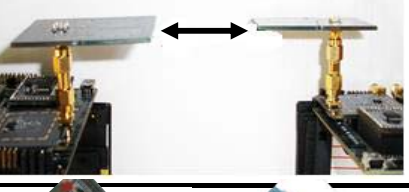

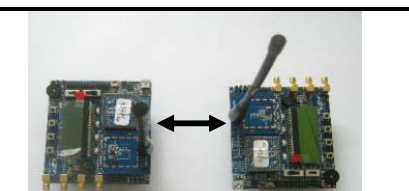
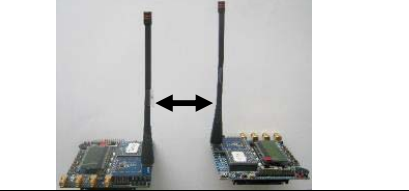
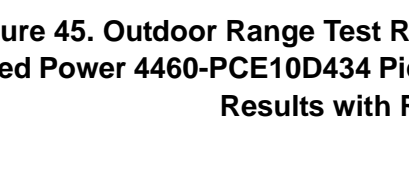
		Set1	10dBm	40kbps	+/-20kHz	GPS		Distance [m]	
		Set2	10dBm	100kbps	+/-50kHz	N	E		
		Set3	0dBm	2.4kbps	+/-2.4kHz				
F	BIFA Antenna				Base	47.152880°	19.180930°	0.0	
BIFA (WES0073)		H pol; Norm. direction					GPS		796.7
							N	E	
		1	Set1	10dBm	40kbps	+/-20kHz	47.158370°	19.174160°	
		V pol; Norm. direction					GPS		885.5
							N	E	
		2	Set1	10dBm	40kbps	+/-20kHz	47.159310°	19.174020°	
		3	Set2	10dBm	100kbps	+/-50kHz	47.155170°	19.176860°	399.4
		4	Set3	0dBm	2.4kbps	+/-2.4kHz	47.159330°	19.174000°	888.2
		Max. direction: XYH 315°					GPS		849.4
							N	E	
5		Set1	10dBm	40kbps	+/-20kHz	47.158940°	19.174090°		
ANT-433-HETH from LINX		V pol; Norm. direction					GPS		1778.7
							N	E	
		6	Set1	10dBm	40kbps	+/-20kHz	47.167850°	19.172640°	
		7	Set3	0dBm	2.4kbps	+/-2.4kHz	47.162300°	19.17351	1188.2
		H pol; Norm. direction					GPS		1315.3
							N	E	
8	Set1	10dBm	40kbps	+/-20kHz	47.163520°	19.173330°			

Figure 45. Outdoor Range Test Results with Two Identical BIFA Antenna Boards Driven by Reduced Power 4460-PCE10D434 Pico Boards and WMB-930 Wireless Motherboards. Range Test Results with Reference Monopoles are Also Shown.

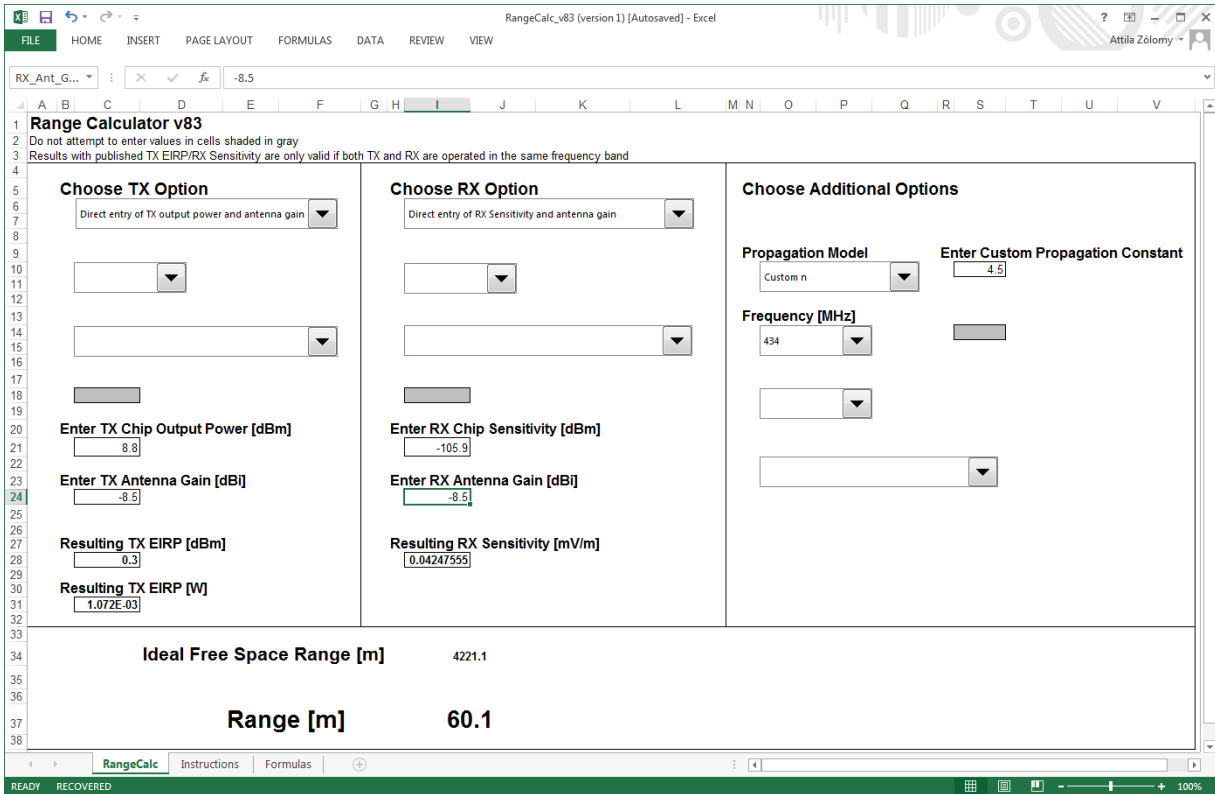


Figure 46. Indoor Range Estimation with Two Identical BIFA Antenna Boards Driven by Reduced Power 4460-PCE10D434 Pico Boards and WMB-930 Wireless Motherboards

5. Medium Sized (Wire) Helical Antenna (WES0074-01-AWH434M-01)

The selected helical antenna is ANT-433-HEATH type from Linx Technology. For more information, go here:

<https://www.linxtechnologies.com/resources/data-guides/ant-xxx-hexx.pdf>

An external matching network (shown in Figure 47) is required at the antenna input.

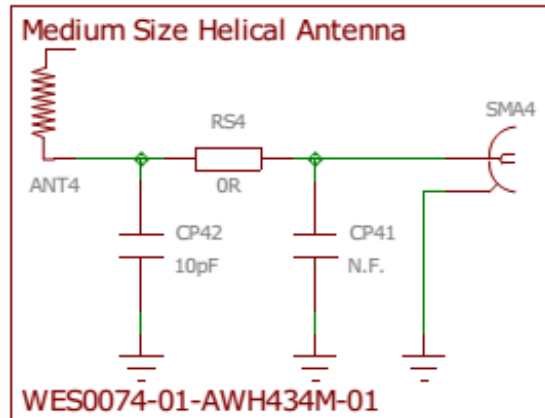


Figure 47. External Matching Network at 434 M for the Medium Helical Antenna

The antenna is shown in Figure 48.

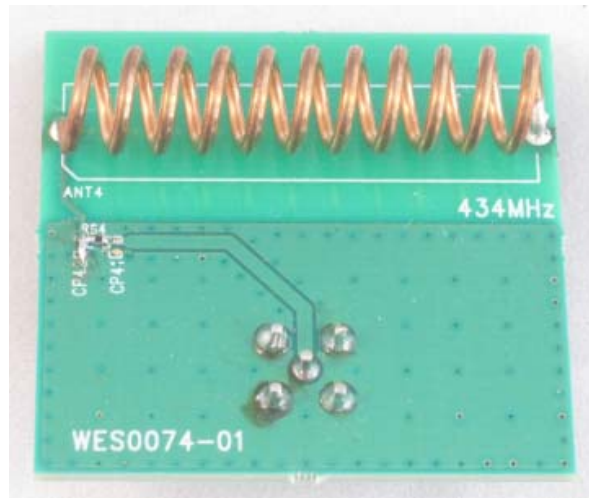


Figure 48. Medium Sized Helical Antenna

5.1. Antenna Impedance (WES0074-01-AWH434M-01)

The impedance measurement setup is shown in Figure 49. In the case of the Medium Sized Helical Antenna, the board is connected to a 4455-PCE10D434 Pico Board through a male-to-male SMA transition with the WMB-930 Wireless Motherboard driving the Pico Board.

During the impedance tuning and range test, the user's hand holds the motherboard. Typical hand position is shown in Figure 49.



**Figure 49. DUT in the Impedance Measurement Setup
(Medium Sized Helical Antenna Board [WES0074])**



Figure 50. Medium Sized Helical Antenna Board (WES0074)

The measured impedance of the antenna with its external matching network is shown in Figure 51 (up to 1.5 GHz) with motherboard hand effect.

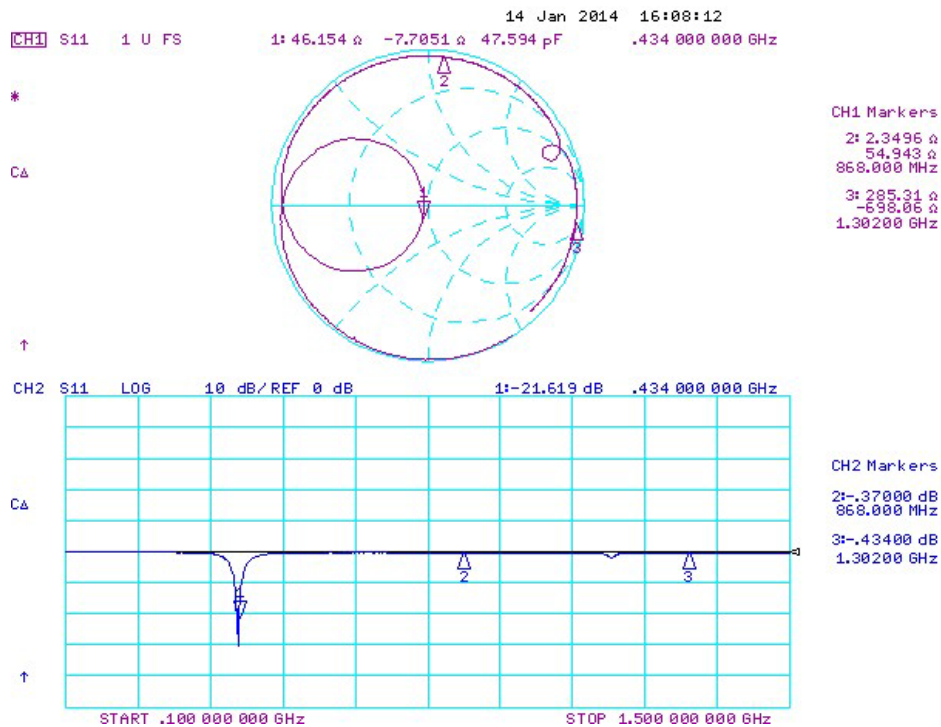


Figure 51. Measured Impedance up to 1.5 GHz with Hand Effect on the Main Board

5.2. Antenna Gain (WES0074-01-AWH434M-01)

The antenna gain is calculated from the measured radiated power at the fundamental and from the delivered power to the antenna determined by a conducted SA measurements on the 50 Ω termination as shown in Figure 52. This method can be effectively applied because the S11 of the antenna is much better than -10 dB, so the reflection is negligible.

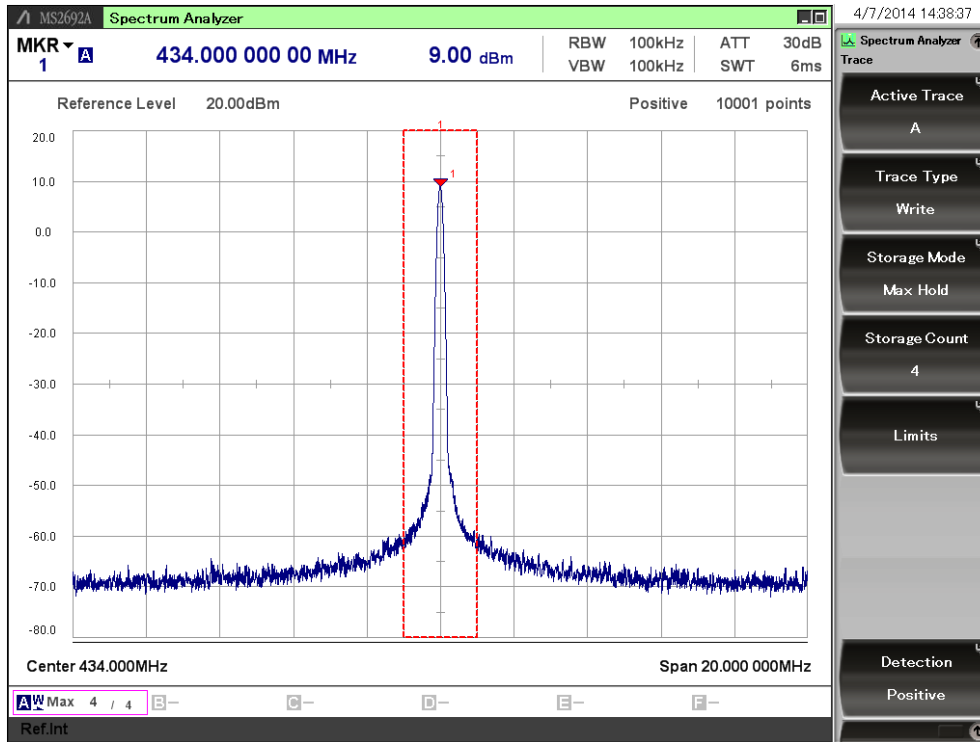


Figure 52. Conducted Measurement Result, 4455-PCE10D434 at Reduced Power Level: the State is 0x4F and V_{DD} is ~2.9 V (Two AA Batteries)

The measured radiated power maximum is at the XZ cut (Table 5). It is around +12 dBm EIRP, so the maximum gain number is ~+3 dBi, as it is shown in Figure 56.

5.3. Radiation Patterns (WES0074-01-AWH434M-01)

The radiation patterns of the medium sized helical antenna were measured in an antenna chamber using the 4455-PCE10D434 Pico Board connected through a male-to-male SMA transition with the WMB-930 Wireless Motherboard driving the Pico Board. Figure 54—Figure 59 show the radiation patterns at the fundamental frequency in the XY, XZ, YZ cut, with both horizontal and vertical receiver antenna polarization. The rotator was stepped in five degrees to record the radiation pattern in 360 degrees.

The DUT with coordinate system under the radiated measurements is shown in Figure 53. In the XY cut the rotation starts from the X-axis, while in the XZ and YZ cuts rotation starts from the Z-axis.

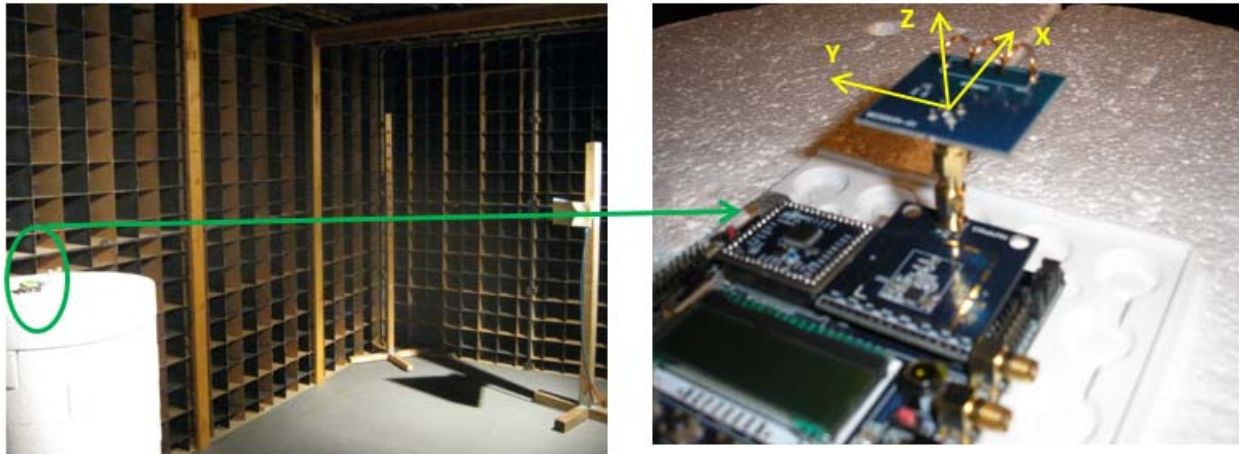


Figure 53. DUT in the Antenna Chamber

The measured radiation patterns (antenna gain in dBi) are shown in the following six figures (Figure 54—Figure 59).

**Radiation Pattern in dBi, 434MHz Horizontal
Helical XYV**

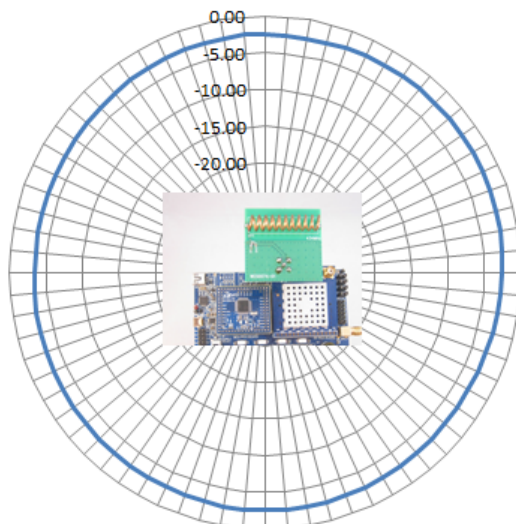


Figure 54. Radiation Pattern in the XY Cut with Vertical Receiver Antenna Polarization

**Radiation Pattern in dBi, 434MHz Horizontal
Helical XYH**

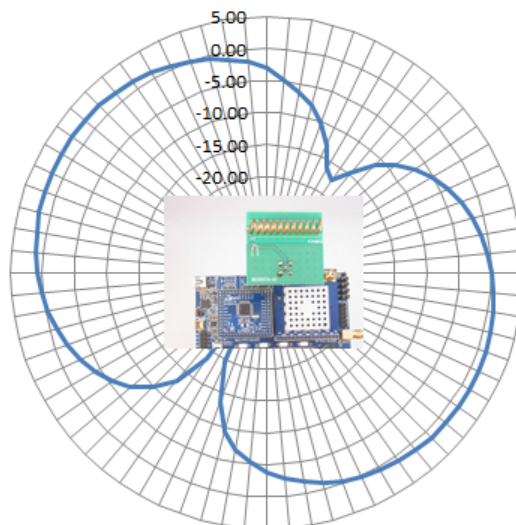


Figure 55. Radiation Pattern in the XY Cut with Horizontal Receiver Antenna Polarization

**Radiation Pattern in dBi, 434MHz Horizontal
Helical XZV**

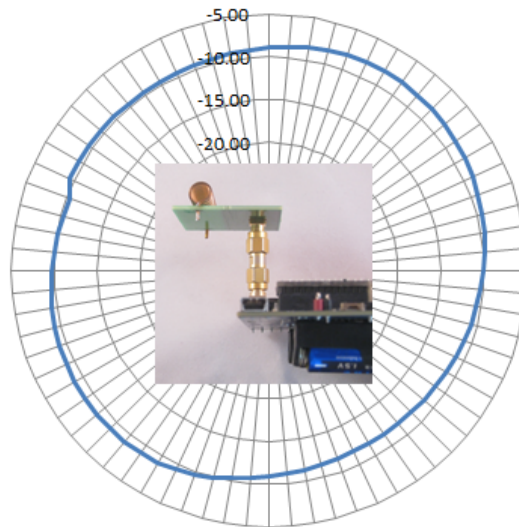


Figure 56. Radiation Pattern in the XZ Cut with Vertical Receiver Antenna Polarization

**Radiation Pattern in dBi, 434MHz Horizontal
Helical XZH**

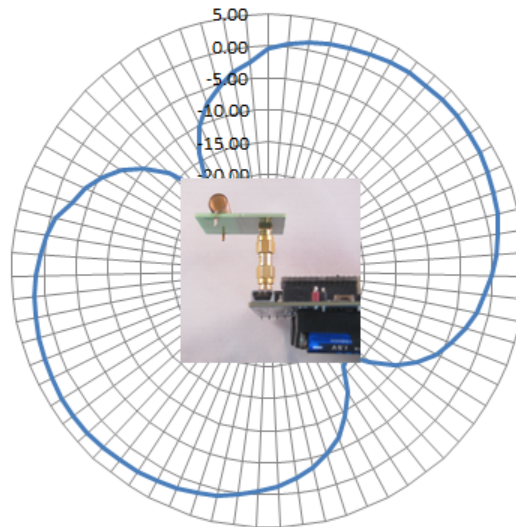


Figure 57. Radiation Pattern in the XZ Cut with Horizontal Receiver Antenna Polarization

**Radiation Pattern in dBi, 434MHz Horizontal
Helical YZV**

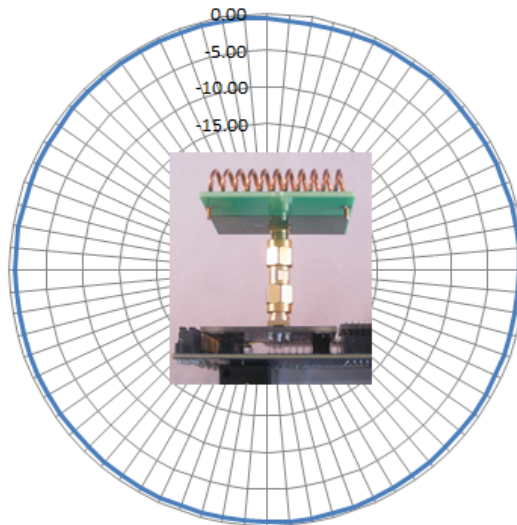


Figure 58. Radiation Pattern in the YZ Cut with Vertical Receiver Antenna Polarization

**Radiation Pattern in dBi, 434MHz Horizontal
Helical YZH**

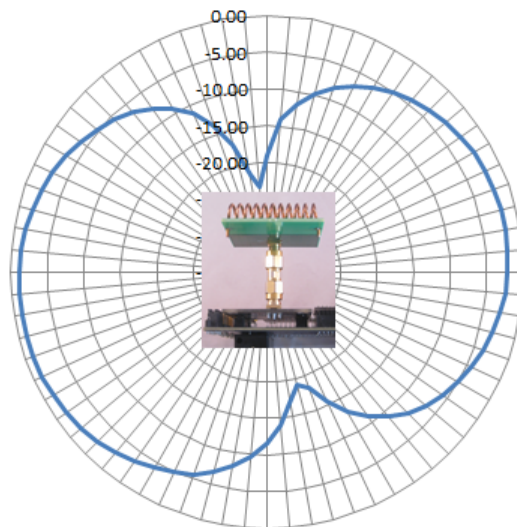


Figure 59. Radiation Pattern in the YZ Cut with Horizontal Receiver Antenna Polarization

5.4. Radiated Harmonics (WES0074-01-AWH434M-01)

The radiated harmonics of the medium sized helical antenna were also measured in an antenna chamber using the 4455-PCE10D434 Pico Board connected through a male-to-male SMA transition with the WMB-930 Wireless Motherboard driving the Pico Board. The 4455-PCE10D434 Pico Board is set to a power state of 0x4F and a V_{DD} of ~2.9 V (two AA batteries) to deliver ~+9 dBm as Figure 52 shows. The maximum radiated power levels, up to the 10th harmonic, were measured in the XY, XZ, and YZ cut, with both horizontal and vertical polarized receiver antenna. The results are shown in the following EIRP table (Table 5) together with the corresponding standard limits.

The Antenna is ETSI compliant, with large enough margin.

Table 5. Radiated Harmonics, Medium Helical Antenna Board Driven by the 4455-PCE10D434 Pico Board in Reduced Power (~+9 dBm) Level and by the WMB-930 Wireless Motherboard

Cut.	Pol.	Freq.	f [MHz]	ETSI limit in EIRP [dBm]	Measured radiated power in EIRP [dBm]	Margin [dB]
XY	V	Fund.	434	12.14	6.78	5.4
XY	V	2 nd	868	-33.88	-65.49	31.6
XY	V	3 rd	1302	-27.86	-65.54	37.7
XY	V	4 th	1736	-27.86	-43.48	15.6
XY	V	5 th	2170	-27.86	-41.22	13.4
XY	V	6 th	2604	-27.86	-49.39	21.5
XY	V	7 th	3038	-27.86	-48.63	20.8
XY	V	8 th	3472	-27.86	-43.13	15.3
XY	V	9 th	3906	-27.86	-50.21	22.3
XY	V	10 th	4340	-27.86	-45.76	17.9
XY	H	Fund.	434	12.14	11.13	1.0
XY	H	2 nd	868	-33.88	-71.12	37.2
XY	H	3 rd	1302	-27.86	-69.44	41.6
XY	H	4 th	1736	-27.86	-47.94	20.1
XY	H	5 th	2170	-27.86	-49.68	21.8
XY	H	6 th	2604	-27.86	-44.64	16.8
XY	H	7 th	3038	-27.86	-45.37	17.5
XY	H	8 th	3472	-27.86	-43.87	16.0
XY	H	9 th	3906	-27.86	-49.28	21.4

Table 5. Radiated Harmonics, Medium Helical Antenna Board Driven by the 4455-PCE10D434 Pico Board in Reduced Power (~+9 dBm) Level and by the WMB-930 Wireless Motherboard(Continued)

Cut.	Pol.	Freq.	f [MHz]	ETSI limit in EIRP [dBm]	Measured radiated power in EIRP [dBm]	Margin [dB]
XY	H	10 th	4340	-27.86	-47.54	19.7
XZ	V	Fund.	434	12.14	0.89	11.2
XZ	V	2 nd	868	-33.88	-67.64	33.8
XZ	V	3 rd	1302	-27.86	-64.26	36.4
XZ	V	4 th	1736	-27.86	-47.30	19.4
XZ	V	5 th	2170	-27.86	-49.79	21.9
XZ	V	6 th	2604	-27.86	-47.77	19.9
XZ	V	7 th	3038	-27.86	-47.90	20.0
XZ	V	8 th	3472	-27.86	-45.69	17.8
XZ	V	9 th	3906	-27.86	-52.05	24.2
XZ	V	10 th	4340	-27.86	-44.72	16.9
XZ	H	Fund.	434	12.14	11.98	0.2
XZ	H	2 nd	868	-33.88	-67.91	34.0
XZ	H	3 rd	1302	-27.86	-69.64	41.8
XZ	H	4 th	1736	-27.86	-48.84	21.0
XZ	H	5 th	2170	-27.86	-45.50	17.6
XZ	H	6 th	2604	-27.86	-45.45	17.6
XZ	H	7 th	3038	-27.86	-46.15	18.3
XZ	H	8 th	3472	-27.86	-42.79	14.9
XZ	H	9 th	3906	-27.86	-54.72	26.9
XZ	H	10 th	4340	-27.86	-44.46	16.6
YZ	V	Fund.	434	12.14	8.53	3.6
YZ	V	2 nd	868	-33.88	-67.63	33.7

Table 5. Radiated Harmonics, Medium Helical Antenna Board Driven by the 4455-PCE10D434 Pico Board in Reduced Power (~+9 dBm) Level and by the WMB-930 Wireless Motherboard(Continued)

Cut.	Pol.	Freq.	f [MHz]	ETSI limit in EIRP [dBm]	Measured radiated power in EIRP [dBm]	Margin [dB]
YZ	V	3 rd	1302	-27.86	-63.45	35.6
YZ	V	4 th	1736	-27.86	-47.37	19.5
YZ	V	5 th	2170	-27.86	-48.24	20.4
YZ	V	6 th	2604	-27.86	-48.40	20.5
YZ	V	7 th	3038	-27.86	-47.56	19.7
YZ	V	8 th	3472	-27.86	-40.66	12.8
YZ	V	9 th	3906	-27.86	-52.63	24.8
YZ	V	10 th	4340	-27.86	-46.40	18.5
YZ	H	Fund.	434	12.14	8.02	4.1
YZ	H	2 nd	868	-33.88	-68.64	34.8
YZ	H	3 rd	1302	-27.86	-67.91	40.0
YZ	H	4 th	1736	-27.86	-46.53	18.7
YZ	H	5 th	2170	-27.86	-50.37	22.5
YZ	H	6 th	2604	-27.86	-48.34	20.5
YZ	H	7 th	3038	-27.86	-52.80	24.9
YZ	H	8 th	3472	-27.86	-44.86	17.0
YZ	H	9 th	3906	-27.86	-54.17	26.3
YZ	H	10 th	4340	-27.86	-43.94	16.1

5.5. Range Test (WES0074-01-AWH434M-01)

The available range was measured using the Range Test Demo. This application is supplied with the standard development kits for EZRadioPRO®. The target of this measurement is to find the distance between the transceivers where the one-directional PER (Packet Error Rate, number of lost packets) is not more than 1% at each side with ten byte packet length. The GPS coordinates have been recorded for each spot. The distance between the spots has been measured using Google Maps, and results are shown in meters. The range was tested with two identical units held in hands, as shown in Figure 50. Each unit comprises a WMB-930 Wireless Motherboard, a 4460-PCE10D434 Pico Board, and the DUT (as shown in Figure 50). The 4460-PCE10D434 Pico Board is set to its normal (~+10 dBm) or to a reduced (~0 dBm) power state. However, the nominal +10 dBm power setting (state of 0x2D) is valid at 3.3 V V_{DD} only. At 3 V V_{DD} , supplied by the two AA batteries, the power level is lower, around +8.8 dBm. At the nominal 0 dBm setting (state of 0x07) the power decrease is negligible at 3 V V_{DD} .

The range was tested in a flat land area without obstacles.

During the range test, the following settings were used:

- Set 1: Txpow=10 dBm (~8.8 dBm @ 3 V V_{DD}), 40 kbps, 20 kHz dev., RXBW=82.64 kHz (sens ~-105.5 dBm)
- Set 2: Txpow=10 dBm (~8.8 dBm @ 3 V V_{DD}), 100 kbps, 50 kHz dev., RXBW=206.12 kHz (sens ~-100.7 dBm)
- Set 3: Txpow=0 dBm, 2.4 kbps, 2.4 kHz dev., RXBW=25.77 kHz (sens ~-115.9 dBm)

Using the above settings (Set 1, Set 2, and Set 3) the following range tests are done here:

1. Range measurement with the MEDIUM HELICAL Antenna Boards—The antenna boards are HORIZONTALLY polarized and the X-axes are facing each other (i.e., normal usage position). The applied setting is "Set 1".
2. Range measurement with the MEDIUM HELICAL Antenna Boards—The antenna boards are VERTICALLY polarized and the X-axes are facing each other (i.e., normal usage position). The applied setting is "Set 1".
3. Range measurement with the MEDIUM HELICAL Antenna Boards—The antenna boards are VERTICALLY polarized and the X-axes are facing each other (i.e., normal usage position). The applied setting is "Set 2".
4. Range measurement with the MEDIUM HELICAL Antenna Boards—The antenna boards are VERTICALLY polarized and the X-axes are facing each other (i.e., normal usage position). The applied setting is "Set 3".
5. Range measurement with the MEDIUM HELICAL Antenna Boards—The antenna boards are VERTICALLY polarized and the boards are facing each other in their direction of maximum radiation. The applied setting is "Set 1".
6. Reference range measurement with two 434 MHz REFERENCE MONOPOLE (ANT-433-HETH from Linx Technologies) in VERTICAL polarization using the setting denoted by "Set 1".
7. Reference range measurement with two 434 MHz REFERENCE MONOPOLE (ANT-433-HETH from Linx Technologies) in VERTICAL polarization using the setting denoted by "Set 3".
8. Reference range measurement with a 434 MHz REFERENCE MONOPOLE (ANT-433-HETH from Linx Technologies) in HORIZONTAL polarization using the setting denoted by "Set 1".

The measurement results are summarized in Figure 60.

The indoor range test was not performed, due to the lack of a large enough building. But from the TX power and sensitivity data, an indoor range estimation can be given if one assumes a propagation factor of 4.5, which is a typical value in normal office environments. Use the Silicon Labs' range calculator, which can be found here:

<http://www.silabs.com/support/pages/document-library.aspx?p=Wireless&f=EZRadioPRO&pn=Si4460>

Assuming a -2.4 dBi antenna gain (front direction, X-axes facing) in the XY cut and setting "Set 1" (40 kbps, 1% PER, +8.8 dBm), the estimated indoor range is 112 m, as shown in Figure 61. To the maximum antenna gain direction the indoor range between two identical units is ~195 m.

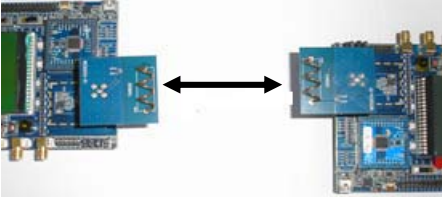
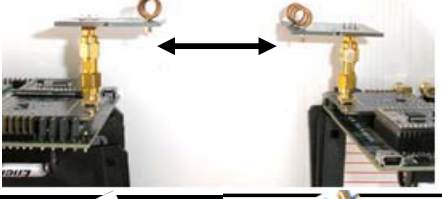
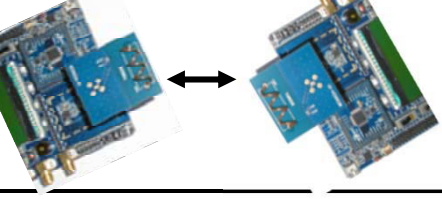
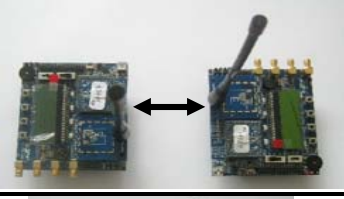
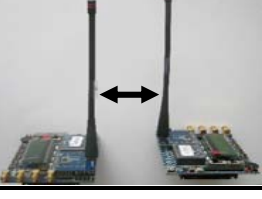
		<table border="1"> <tr><td>Set1</td><td>10dBm</td><td>40kbps</td><td>+/-20kHz</td></tr> <tr><td>Set2</td><td>10dBm</td><td>100kbps</td><td>+/-50kHz</td></tr> <tr><td>Set3</td><td>0dBm</td><td>2.4kbps</td><td>+/-2.4kHz</td></tr> </table>				Set1	10dBm	40kbps	+/-20kHz	Set2	10dBm	100kbps	+/-50kHz	Set3	0dBm	2.4kbps	+/-2.4kHz	<table border="1"> <tr><th colspan="2">GPS</th></tr> <tr><th>N</th><th>E</th></tr> </table>		GPS		N	E	Distance [m]
Set1	10dBm	40kbps	+/-20kHz																					
Set2	10dBm	100kbps	+/-50kHz																					
Set3	0dBm	2.4kbps	+/-2.4kHz																					
GPS																								
N	E																							
F	Medium Helical			Base	47.152880°	19.180930°	0.0																	
Medium Helical (WES0074)		H pol; Norm. direction				GPS		1089.9																
						N	E																	
		1	Set1	10dBm	40kbps	+/-20kHz	47.161360°		19.173700°															
		V pol; Norm. direction				GPS		1193.8 962.8 1236.0																
						N	E																	
		2	Set1	10dBm	40kbps	+/-20kHz	47.162360°		19.173520°															
		3	Set2	10dBm	100kbps	+/-50kHz	47.160090°		19.173880°															
		Max. direction: XYH 300°				GPS		1349.7																
					N	E																		
5		Set1	10dBm	40kbps	+/-20kHz	47.163850°	19.173290°																	
ANT-433-HEATH from LINX		V pol; Norm. direction				GPS		1778.7 1188.2																
						N	E																	
		6	Set1	10dBm	40kbps	+/-20kHz	47.167850°		19.172640°															
		H pol; Norm. direction				GPS		1315.3																
						N	E																	
		8	Set1	10dBm	40kbps	+/-20kHz	47.163520°		19.173330°															

Figure 60. Outdoor Range Test Results with Two Identical Medium Sized Helical Antenna Boards Driven by Reduced Power 4460-PCE10D434 Pico Boards and WMB-930 Wireless Motherboards. Range Test Results with Reference Monopoles are Also Shown.

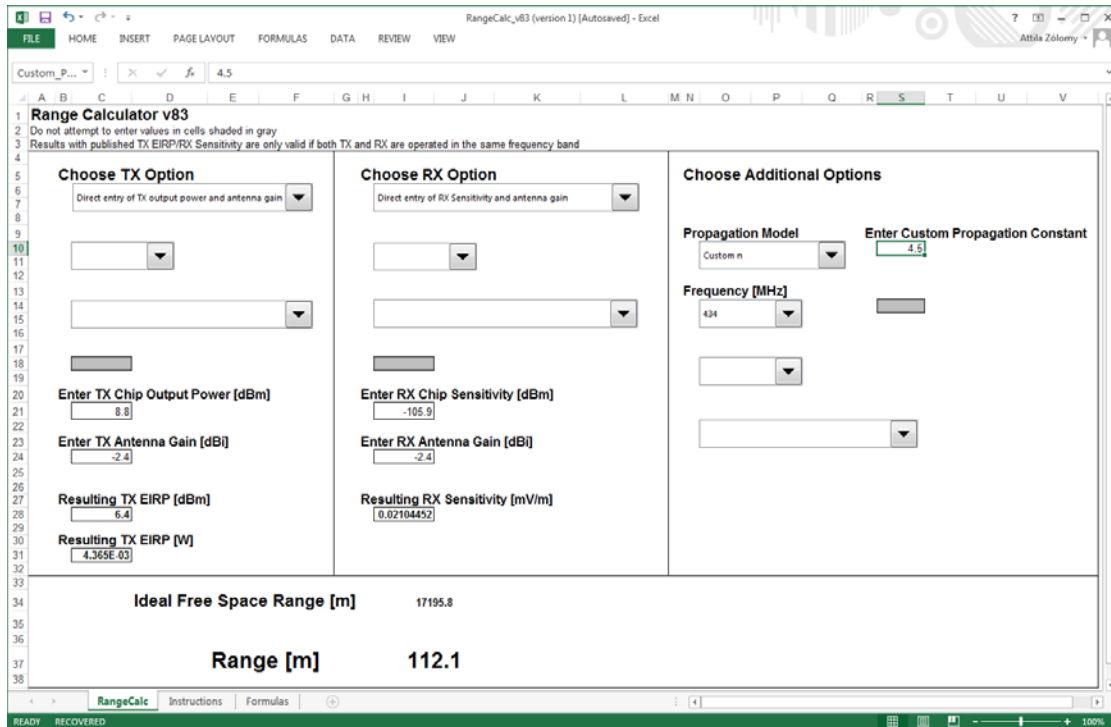


Figure 61. Indoor Range Estimation with Two Identical Medium Sized Helical Antenna Boards Driven by Reduced Power 4460-PCE10D434 Pico Boards and WMB-930 Wireless Motherboards

6. Panic Button IFA (WES0075-01-APF434P-01)

The Panic Button IFA antenna has the following characteristics:

- The antenna trace width is 0.5 mm.
- The distance between the antenna trace outer edge and the PCB cutting edge is 1.5 mm.
- The distance between the antenna trace inner edge and ground metal is 2 mm.
- No capacitance (C_{top}) at the end of the antenna is required.
- No parallel capacitance or any other matching element at the antenna input is required. Only a series $0\ \Omega$ is used to connect the antenna as it is shown in Figure 63.

The antenna is shown in Figure 64.

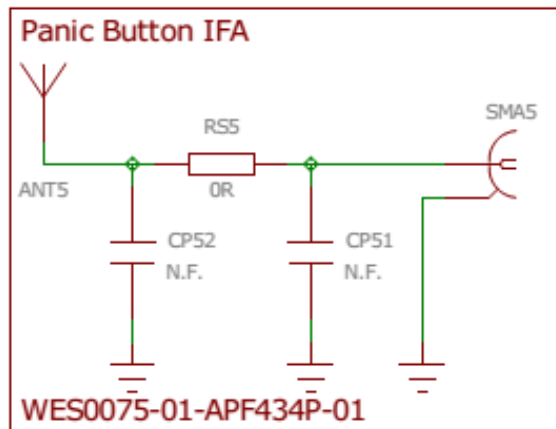


Figure 62. External Matching Network for the Panic Button IFA Antenna



Figure 63. Small IFA Antenna for Panic Button Applications

6.1. Antenna Impedance (WES0075-01-APF434P-01)

The impedance measurement setup is shown in Figure 64. The antenna board is connected to the 4455-PCE10D434 Pico Board through a male-to-male SMA transition with the WMB-930 Wireless Motherboard driving the Pico Board.

During the range test, the user's hand holds the motherboard. Typical hand position is shown in Figure 65.



**Figure 64. DUT in the Impedance Measurement Setup
(Panic Button IFA Antenna Board [WES0075])**



Figure 65. Typical Hand Effect on the Main Board during Impedance and Range Measurement (Panic Button IFA [WES0075] Antenna Board)

The measured impedance of the antenna with its external matching network is shown in Figure 66 (up to 1.5 GHz) with motherboard hand effect.

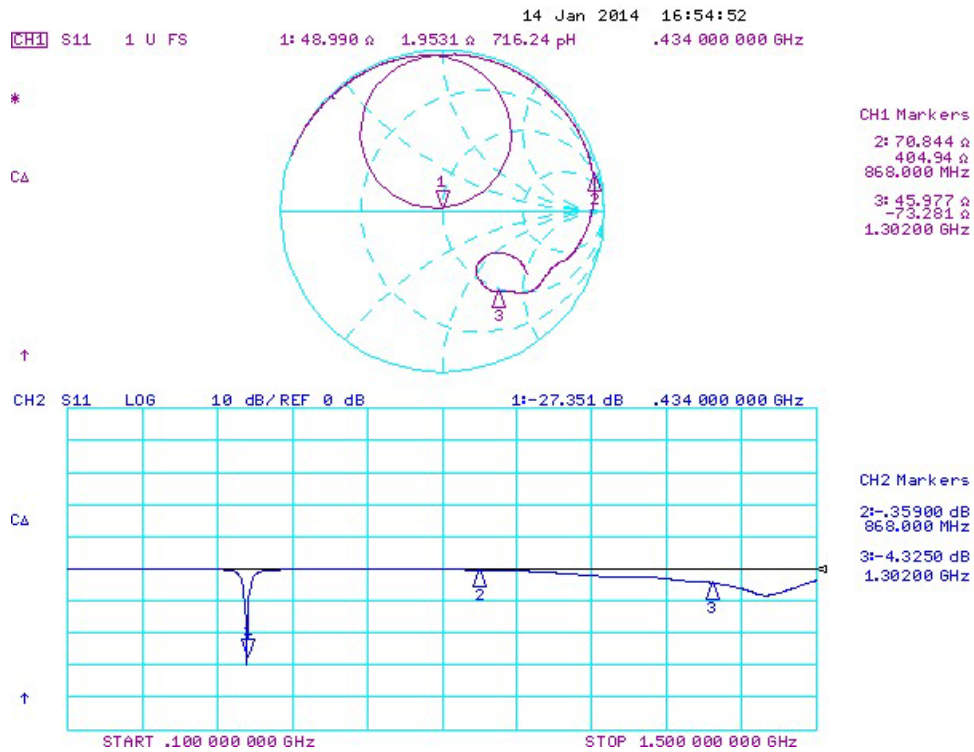


Figure 66. Measured Impedance up to 1.5 GHz with Hand Effect on the Main Board

6.2. Antenna Gain (WES0075-01-APF434P-01)

The antenna gain is calculated from the measured radiated power at the fundamental and from the delivered power to the antenna. In the radiation measurement the 4455-PCE10D434 Pico Board is set to a reduced ($\sim+9$ dBm) power level and the entire setup is fed by two AA batteries. The conducted SA measurement result of the 4455-PCE10D434 Pico Board in this reduced ($\sim+10$ dBm) power state is shown in Figure 67. This method can be effectively applied because the S11 of the antenna is much better than -10 dB, so the reflection is negligible.

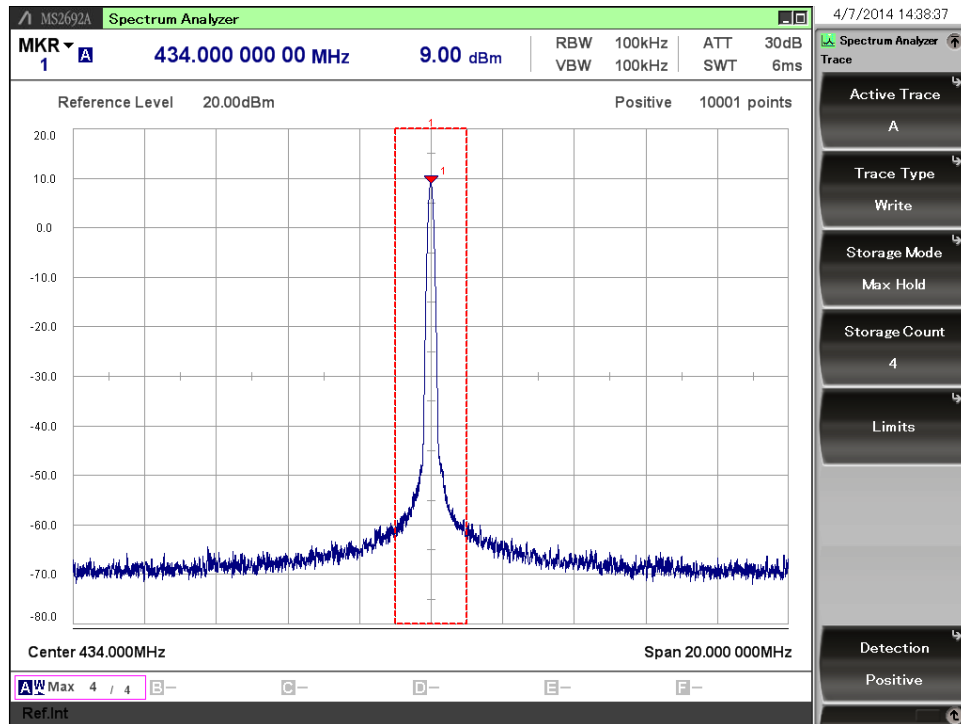


Figure 67. Conducted Measurement Result, 4455-PCE10D434 in Reduced ($\sim+9$ dBm) Power Level: the State is 0x4F, and V_{DD} is ~ 2.9 V (Two AA Batteries)

The measured radiated power maximum is at the XZ cut (Table 6). It is around 4 dBm EIRP, so the maximum gain number is ~-5 dBi, as shown in Figure 72.

This gain number is surprisingly high for a panic button antenna. It should be emphasized that in typical panic button applications the grounding environment and the strength of the hand effect is different. In real panic button applications (instead of the SMA connector, SMA male-male transition, Pico Board and wireless motherboard), only a lithium coin battery is applied and the achievable antenna gain is much weaker.

Also, in wrist applications the very close parallel hand has a strong detuning effect. In these applications, further impedance tuning of the antenna is required, and the radiation efficiency degrades strongly. Refer to the application note, "AN853: Single-ended Antenna Matrix Design Guide" for more information.

6.3. Radiation Patterns (WES0075-01-APF434P-01)

The radiation patterns of the small IFA antenna were measured in an antenna chamber using the 4455-PCE10D434 Pico Board connected through a male-to-male SMA transition with the WMB-930 Wireless Motherboard driving the Pico Board. Figure 69—Figure 74 show the radiation patterns at the fundamental frequency in the XY, XZ, and YZ cut, with both horizontal and vertical receiver antenna polarization. The rotator was stepped in five degrees to record the radiation pattern in 360 degrees.

The DUT with coordinate system under the radiated measurements is shown in Figure 68. In the XY cut the rotation starts from the X-axis, while in the XZ and YZ cuts rotation starts from the Z-axis.

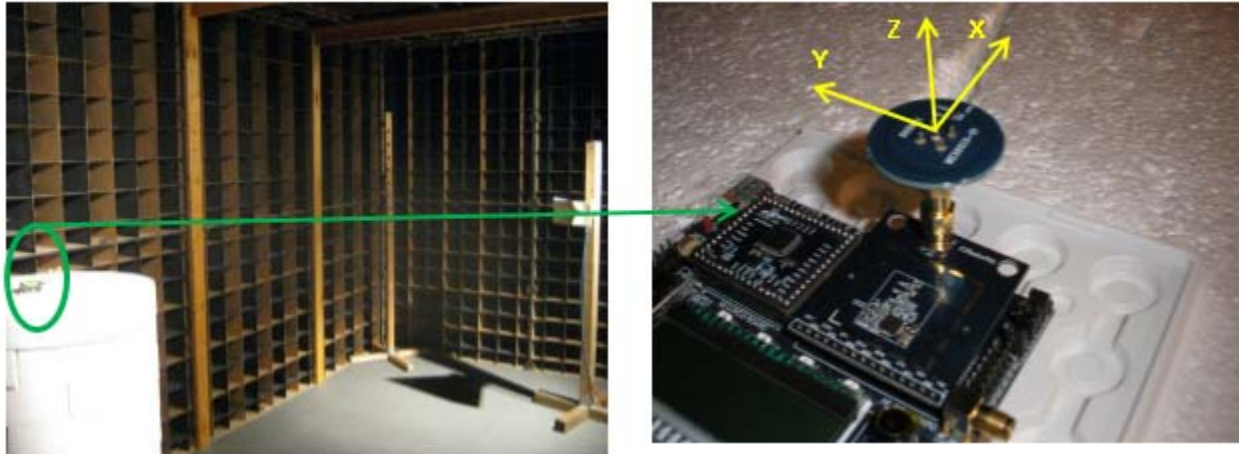


Figure 68. DUT in the Antenna Chamber

The measured radiation patterns (antenna gain in dBi) are shown in the following six figures (Figure 69–Figure 74).

**Radiation Pattern in dBi, 434MHz Panic IFA
XYV**

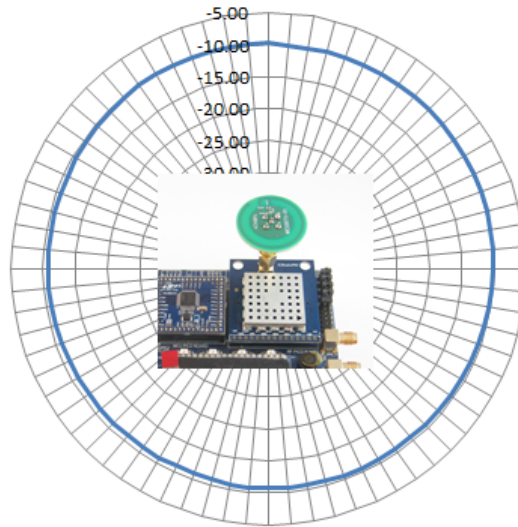


Figure 69. Radiation Pattern in the XY Cut with Vertical Receiver Antenna Polarization

**Radiation Pattern in dBi, 434MHz Panic IFA
XYH**

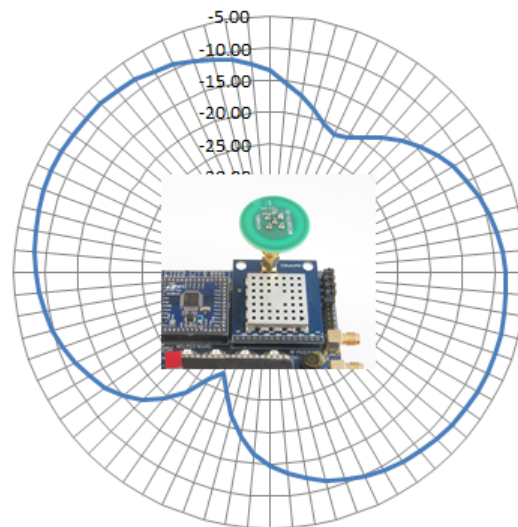


Figure 70. Radiation Pattern in the XY Cut with Horizontal Receiver Antenna Polarization

Radiation Pattern in dBi, 434MHz Panic IFA
XZV

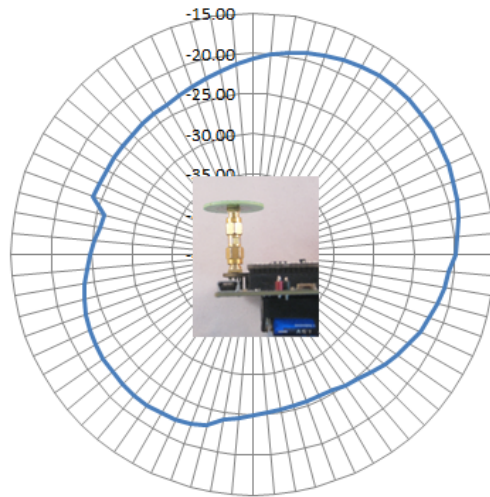


Figure 71. Radiation Pattern in the XZ Cut with Vertical Receiver Antenna Polarization

Radiation Pattern in dBi, 434MHz Panic IFA
XZH

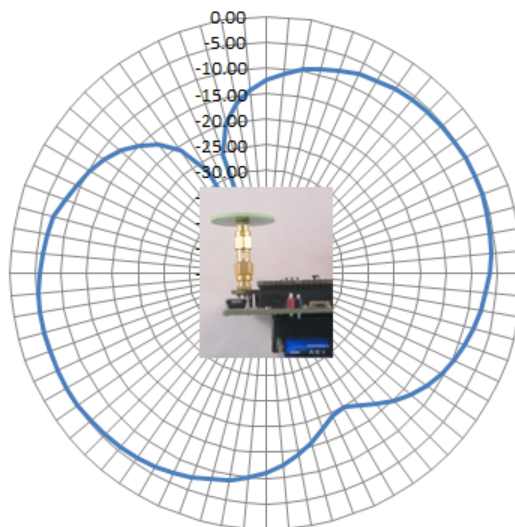


Figure 72. Radiation Pattern in the XZ Cut with Horizontal Receiver Antenna Polarization

Radiation Pattern in dBi, 434MHz Panic IFA
YZV

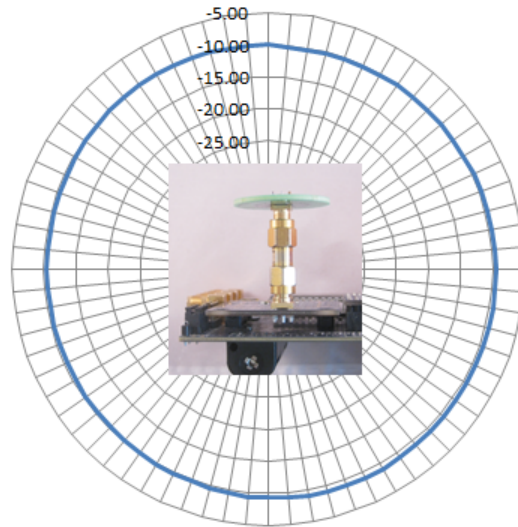


Figure 73. Radiation Pattern in the YZ Cut with Vertical Receiver Antenna Polarization

Radiation Pattern in dBi, 434MHz Panic IFA
YZH

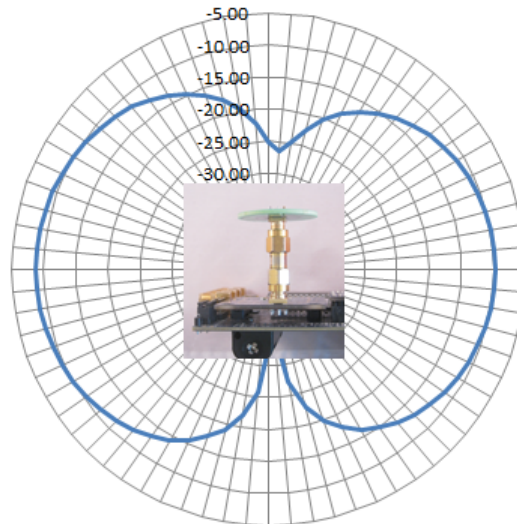


Figure 74. Radiation Pattern in the YZ Cut with Horizontal Receiver Antenna Polarization

6.4. Radiated Harmonics (WES0075-01-APF434P-01)

The radiated harmonics of the small Panic IFA antenna were also measured in an antenna chamber using the 4455-PCE10D434 Pico Board connected through a male-to-male SMA transition with the WMB-930 Wireless Motherboard driving the Pico Board. The 4455-PCE10D434 Pico Board is set to a power state of 0x4F and a V_{DD} of ~2.9 V (two AA batteries) to deliver ~9 dBm, as shown in Figure 67. The maximum radiated power levels, up to the 10th harmonic, were measured in the XY, XZ, and YZ cut with both horizontal and vertical polarized receiver antenna. The results are shown in the following EIRP table (Table 6) together with the corresponding standard limits.

The small sized panic button IFA antenna driven by the Si4455/60 Class E match complies with the ETSI harmonic regulations.

Table 6. Radiated Harmonics, Panic Button IFA Board Connected to Reduced Power (~+9 dBm) 4455-PCE10D434 Driven by WMB-930 Wireless Motherboard

Cut.	Pol.	Freq.	f [MHz]	ETSI limit in EIRP [dBm]	Measured radiated power in EIRP [dBm]	Margin [dB]
XY	V	Fund.	434	12.14	-0.74	12.9
XY	V	2 nd	868	-33.88	-70.76	36.9
XY	V	3 rd	1302	-27.86	-66.79	38.9
XY	V	4 th	1736	-27.86	-45.68	17.8
XY	V	5 th	2170	-27.86	-45.41	17.5
XY	V	6 th	2604	-27.86	-48.82	21.0
XY	V	7 th	3038	-27.86	-56.41	28.6
XY	V	8 th	3472	-27.86	-46.96	19.1
XY	V	9 th	3906	-27.86	-51.31	23.5
XY	V	10 th	4340	-27.86	-43.31	15.5
XY	H	Fund.	434	12.14	1.57	10.6
XY	H	2 nd	868	-33.88	-70.53	36.6
XY	H	3 rd	1302	-27.86	-69.10	41.2
XY	H	4 th	1736	-27.86	-48.97	21.1
XY	H	5 th	2170	-27.86	-51.43	23.6
XY	H	6 th	2604	-27.86	-49.31	21.4
XY	H	7 th	3038	-27.86	-56.57	28.7
XY	H	8 th	3472	-27.86	-48.28	20.4
XY	H	9 th	3906	-27.86	-51.04	23.2

**Table 6. Radiated Harmonics, Panic Button IFA Board Connected to Reduced Power (~+9 dBm)
4455-PCE10D434 Driven by WMB-930 Wireless Motherboard(Continued)**

Cut.	Pol.	Freq.	f [MHz]	ETSI limit in EIRP [dBm]	Measured radiated power in EIRP [dBm]	Margin [dB]
XY	H	10 th	4340	-27.86	-43.80	15.9
XZ	V	Fund.	434	12.14	-8.77	20.9
XZ	V	2 nd	868	-33.88	-66.76	32.9
XZ	V	3 rd	1302	-27.86	-67.25	39.4
XZ	V	4 th	1736	-27.86	-48.68	20.8
XZ	V	5 th	2170	-27.86	-46.32	18.5
XZ	V	6 th	2604	-27.86	-47.16	19.3
XZ	V	7 th	3038	-27.86	-55.47	27.6
XZ	V	8 th	3472	-27.86	-46.54	18.7
XZ	V	9 th	3906	-27.86	-50.74	22.9
XZ	V	10 th	4340	-27.86	-38.75	10.9
XZ	H	Fund.	434	12.14	3.96	8.2
XZ	H	2 nd	868	-33.88	-70.01	36.1
XZ	H	3 rd	1302	-27.86	-70.36	42.5
XZ	H	4 th	1736	-27.86	-47.32	19.5
XZ	H	5 th	2170	-27.86	-46.36	18.5
XZ	H	6 th	2604	-27.86	-43.00	15.1
XZ	H	7 th	3038	-27.86	-54.80	26.9
XZ	H	8 th	3472	-27.86	-45.84	18.0
XZ	H	9 th	3906	-27.86	-52.94	25.1
XZ	H	10 th	4340	-27.86	-40.69	12.8
YZ	V	Fund.	434	12.14	-0.11	12.3
YZ	V	2 nd	868	-33.88	-66.13	32.3
YZ	V	3 rd	1302	-27.86	-67.48	39.6

**Table 6. Radiated Harmonics, Panic Button IFA Board Connected to Reduced Power (~+9 dBm)
4455-PCE10D434 Driven by WMB-930 Wireless Motherboard(Continued)**

Cut.	Pol.	Freq.	f [MHz]	ETSI limit in EIRP [dBm]	Measured radiated power in EIRP [dBm]	Margin [dB]
YZ	V	4 th	1736	-27.86	-47.41	19.6
YZ	V	5 th	2170	-27.86	-47.86	20.0
YZ	V	6 th	2604	-27.86	-48.97	21.1
YZ	V	7 th	3038	-27.86	-55.14	27.3
YZ	V	8 th	3472	-27.86	-45.64	17.8
YZ	V	9 th	3906	-27.86	-52.48	24.6
YZ	V	10 th	4340	-27.86	-44.76	16.9
YZ	H	Fund.	434	12.14	0.21	11.9
YZ	H	2 nd	868	-33.88	-69.26	35.4
YZ	H	3 rd	1302	-27.86	-69.72	41.9
YZ	H	4 th	1736	-27.86	-47.73	19.9
YZ	H	5 th	2170	-27.86	-49.49	21.6
YZ	H	6 th	2604	-27.86	-43.09	15.2
YZ	H	7 th	3038	-27.86	-58.56	30.7
YZ	H	8 th	3472	-27.86	-47.22	19.4
YZ	H	9 th	3906	-27.86	-52.74	24.9
YZ	H	10 th	4340	-27.86	-40.70	12.8

6.5. Range Test (WES0075-01-APF434P-01)

The available range was measured using the Range Test Demo. This application is supplied with the standard development kits for EZRadioPRO®. The target of this measurement is to find the distance between the transceivers where the one-directional PER (Packet Error Rate, number of lost packets) is not more than 1% at each side with ten byte long packets. The GPS coordinates have been recorded for each spot. The distance between the spots has been measured using Google Maps, and results are shown in meters. The range was tested between two identical units with the WMB-930 Wireless Motherboard, 4460-PCE10D434 Pico Board, and the DUT (as shown in Figure 65) held by the users hand. The 4460-PCE10D434 Pico Board is set to its normal (~+10 dBm) or to a reduced (~0 dBm) power state. However, the nominal +10 dBm power setting (state of 0x2D) is valid at 3.3 V V_{DD} only. At 3 V V_{DD} , supplied by the two AA batteries the power level is lower, around +8.8 dBm. At the nominal 0 dBm setting (state of 0x07) the power decrease is negligible at 3V V_{DD} .

The range was tested in a flat land area without obstacles.

During the range test, the following settings (Set 1, Set 2, and Set 3) were used:

- Set 1: Txpow=10 dBm (~8.8 dBm @ 3 V V_{DD}), 40 kbps, 20 kHz dev., RXBW=82.64 kHz (sens ~-105.5 dBm)
- Set 2: Txpow=10 dBm (~8.8 dBm @ 3 V V_{DD}), 100 kbps, 50 kHz dev., RXBW=206.12 kHz (sens ~-100.7 dBm)
- Set 3: Txpow=0 dBm, 2.4 kbps, 2.4 kHz dev., RXBW=25.77 kHz (sens ~-115.9 dBm)

Using the above settings the following range tests are done here:

1. Range measurement with the PANIC BUTTON IFA Antenna Boards—The antenna boards are HORIZONTALLY polarized and the X-axes are facing each other (i.e., normal usage position). The applied setting is "Set 1".
2. Range measurement with the PANIC BUTTON IFA Antenna Boards—The antenna boards are VERTICALLY polarized and the X-axes are facing each other (i.e., normal usage position). The applied setting is "Set 1".
3. Range measurement with the PANIC BUTTON IFA Antenna Boards—The antenna boards are VERTICALLY polarized and the X-axes are facing each other (i.e., normal usage position). The applied setting is "Set 2".
4. Range measurement with the PANIC BUTTON IFA Antenna Boards—The antenna boards are VERTICALLY polarized and the X-axes are facing each other (i.e., normal usage position). The applied setting is "Set 3".
5. Range measurement with the PANIC BUTTON IFA Antenna Boards—The antenna boards are VERTICALLY polarized and boards are facing each other in their direction of maximum radiation. The applied setting is "Set 1".
6. Reference range measurement with two 434 MHz REFERENCE MONOPOLE (ANT-433-HETH from Linx Technologies) in VERTICAL polarization using the setting denoted by "Set 1".
7. Reference range measurement with two 434 MHz REFERENCE MONOPOLE (ANT-433-HETH from Linx Technologies) in VERTICAL polarization using the setting denoted by "Set 3".
8. Reference range measurement with a 434 MHz REFERENCE MONOPOLE (ANT-433-HETH from Linx Technologies) in HORIZONTAL polarization using the setting denoted by "Set 1".

The measurement results are summarized in Figure 75.

Note: These range test results are valid with the above configuration and with moderate hand effect. In normal battery-operated, small push-button applications, where there is no large GND (motherboard) close to the antenna and where the antenna is usually very close to the user's hand, the achievable range is most likely much shorter.

The indoor range test was not performed, due to the lack of a large enough building. But from the TX power and sensitivity data, an indoor range estimation can be given if one assumes a propagation factor of 4.5, which is a typical value in normal office environments. Use the Silicon Labs' range calculator, which can be found here:

<http://www.silabs.com/support/pages/document-library.aspx?p=Wireless&f=EZRadioPRO&pn=Si4460>

Assuming a -9.7 dBi antenna gain (front direction, X axes facing) and the setting "Set 1" (40 kbps, 1% PER, +8.8 dBm), the estimated indoor range is 53 m, as shown in Figure 76. To the maximum antenna gain direction the indoor range between two identical units is ~86 m.

		Set1	10dBm	40kbps	+/-20kHz	GPS		Distance [m]
		Set2	10dBm	100kbps	+/-50kHz	N	E	
		Set3	0dBm	2.4kbps	+/-2.4kHz			
F	Panic Button IFA				Base	47.152880°	19.180930°	0.0
Panic Button IFA (WES0075)	H pol; Norm. direction					GPS		601.1
						N	E	
	1	Set1	10dBm	40kbps	+/-20kHz	47.156480°	19.175000°	
	V pol; Norm. direction					GPS		992.3
						N	E	
	2	Set1	10dBm	40kbps	+/-20kHz	47.160390°	19.173840°	
	3	Set2	10dBm	100kbps	+/-50kHz	47.156050°	19.175610°	
	4	Set3	0dBm	2.4kbps	+/-2.4kHz	47.158710°	19.174100°	
	Max. direction: XZH 245°					GPS		1125.0
						N	E	
5	Set1	10dBm	40kbps	+/-20kHz	47.161700°	19.173640°		
ANT-433-HETH from LINX	V pol; Norm. direction					GPS		1778.7
						N	E	
	6	Set1	10dBm	40kbps	+/-20kHz	47.167850°	19.172640°	
	7	Set3	0dBm	2.4kbps	+/-2.4kHz	47.162300°	19.17351°	
	H pol; Norm. direction					GPS		1315.3
						N	E	
8	Set1	10dBm	40kbps	+/-20kHz	47.163520°	19.173330°		

Figure 75. Outdoor Range Test Results with Two Identical IFA Panic Button Antenna Boards Driven by Reduced Power 4460-PCE10D434 Pico Boards and WMB-930 Wireless Motherboards. Range Test Results with Reference Monopoles are Also Shown.

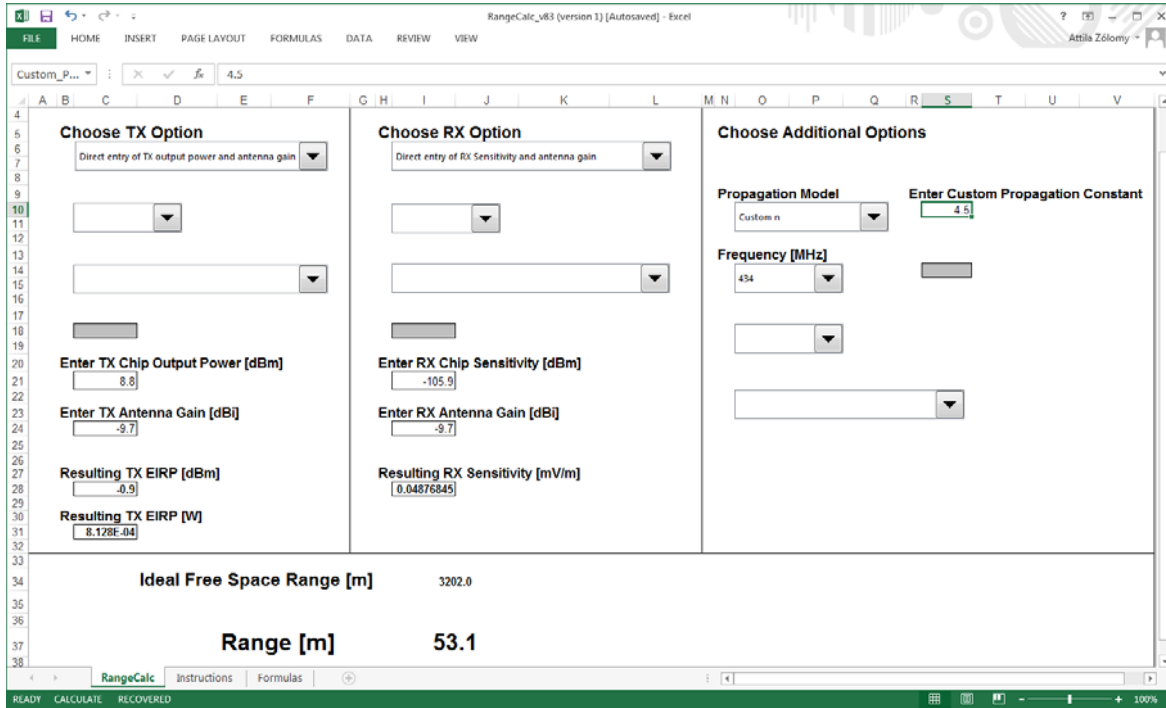


Figure 76. Indoor Range Estimation with Two Identical IFA Panic Button Antenna Boards Driven by Reduced Power 4460-PCE10D434 Pico Boards and WMB-930 Wireless Motherboards

7. Panic Button ILA (Printed) Along the Circumference (WES0076-01-APL434P-01)

The Panic Button ILA antenna has the following characteristics:

- The antenna trace width is 0.5 mm.
- The distance between the antenna trace outer edge and the PCB cutting edge is 1.5 mm.
- The distance between the antenna trace inner edge and ground metal is 2 mm.
- External matching network (shown in Figure 77) is required at the antenna input.

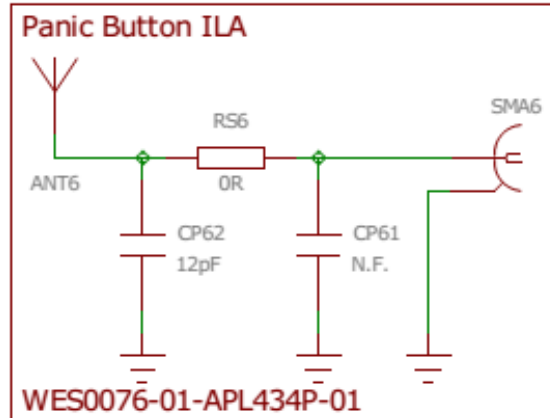


Figure 77. External Matching Network at 434 MHz for the Panic Button ILA Antenna

The antenna is shown in Figure 78.



Figure 78. Small ILA Antenna for Panic Button Applications

7.1. Antenna Impedance (WES0076-01-APL434P-01)

The impedance measurement setup is shown in Figure 79. The antenna board is connected to the 4455-PCE10D434 Pico Board through a male-to-male SMA transition with the WMB-930 Wireless Motherboard driving the Pico Board.

During the range test the user's hand holds the motherboard. Typical hand position is shown in Figure 80.

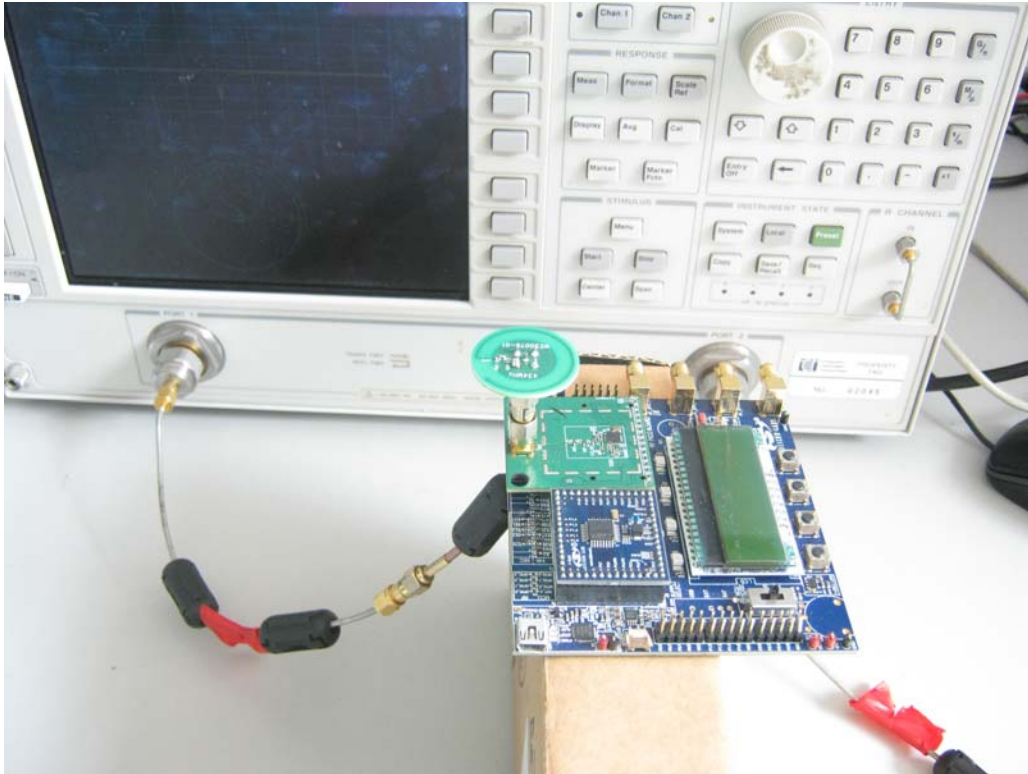


Figure 79. DUT in the Impedance Measurement Setup (Panic Button ILA [WES0076])



Figure 80. Typical Hand Effect on the Main Board During Impedance and Range Measurement (Panic Button ILA Ceramic Antenna Board (WES0076))

The measured impedance of the antenna with its external matching network is shown in Figure 81 (up to 1.5 GHz) with motherboard hand effect.

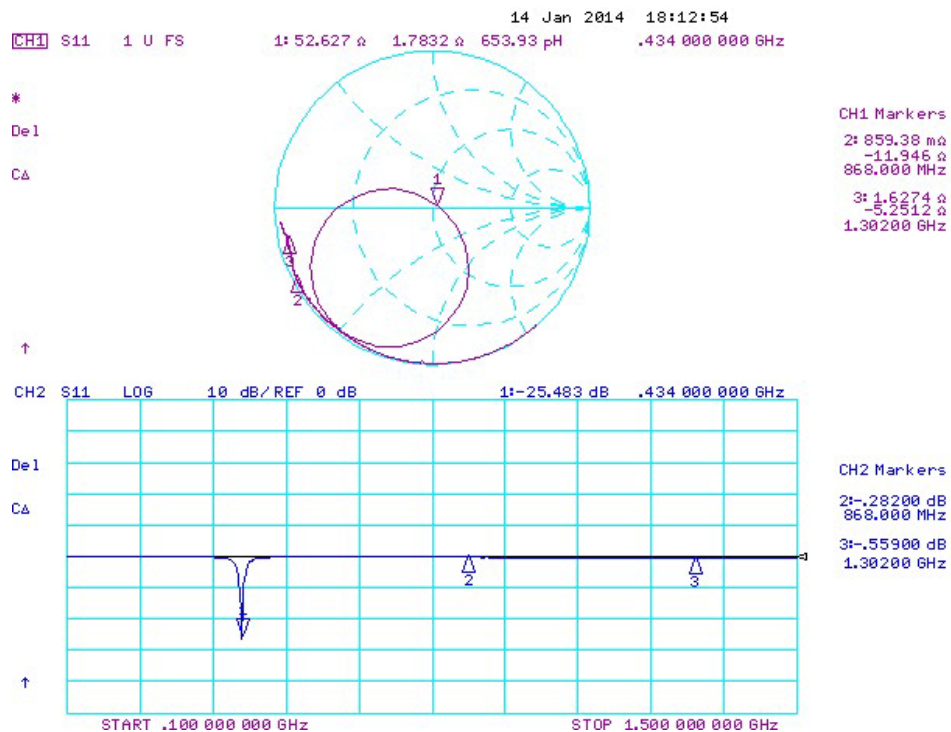


Figure 81. Measured Impedance up to 1.5 GHz with Hand Effect on the Main Board

7.2. Antenna Gain (WES0076-01-APL434P-01)

The antenna gain is calculated from the measured radiated power at the fundamental and from the delivered power to the antenna. In the radiation measurement, the 4455-PCE10D434 Pico Board is set to reduced (~+9 dBm) power level and the entire setup is fed by two AA batteries. The conducted SA measurement result of the 4455-PCE10D434 Pico Board in this reduced (~10 dBm) power state is shown in Figure 82. This method can be effectively applied because the S11 of the antenna is much better than -10 dB, so the reflection loss is negligible.

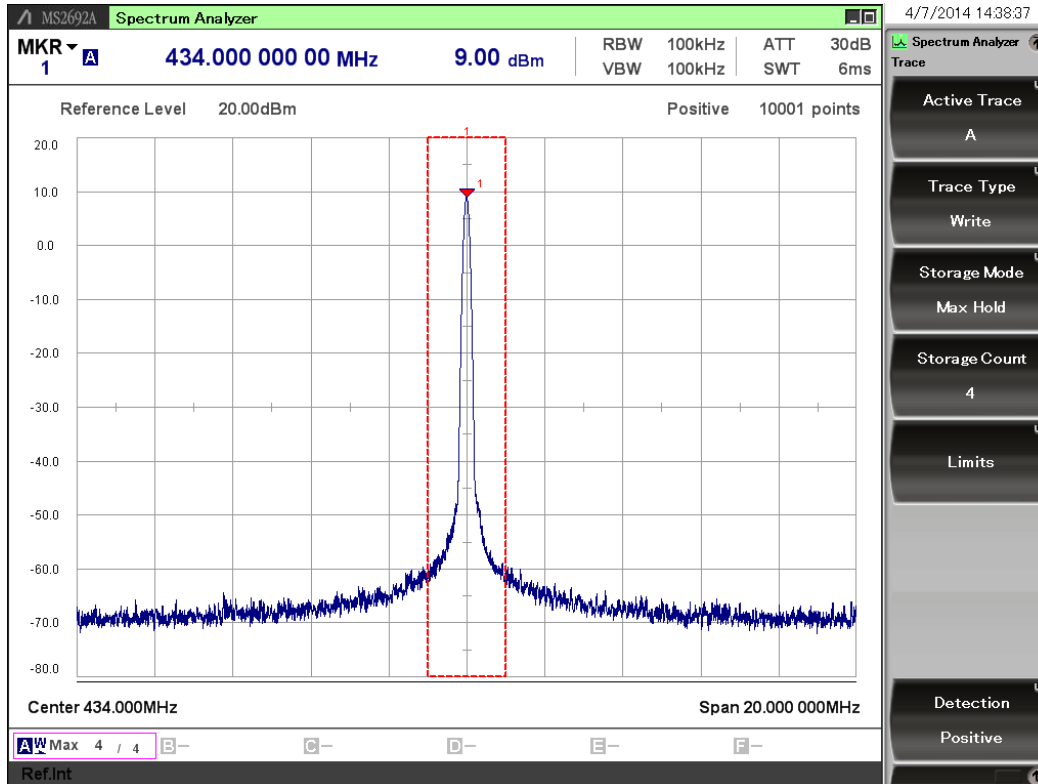


Figure 82. Conducted Measurement Result, 4455-PCE10D434 in Reduced (~+9 dBm) Power Level: the State is 0x4F, and V_{DD} is ~2.9 V (Two AA Batteries)

The measured radiated power maximum is at the XZ cut (Table 7). It is around 4.8 dBm EIRP, so the maximum gain number is ~-4.2 dBi, as shown in Figure 86.

This gain number is surprisingly high for a panic button antenna. It should be emphasized that in typical panic button applications the grounding environment and the strength of the hand effect is different. In real panic button applications (instead of the SMA connector, SMA male-male transition, Pico Board and wireless motherboard) only a lithium coin battery is applied and the achievable antenna gain is much weaker.

Also in wrist applications the very close parallel hand has a strong detuning effect. In these applications further impedance tuning of the antenna is required and the radiation efficiency degrades strongly. Refer to the application note, “AN853: Single-ended Antenna Matrix Design Guide” for more information.

7.3. Radiation Patterns (WES0076-01-APL434P-01)

The radiation patterns of the small ILA antenna were measured in an antenna chamber using the 4455-PCE10D434 Pico Board connected through a male-to-male SMA transition with the WMB-930 Wireless Motherboard driving the Pico Board. Figure 84—Figure 89 show the radiation patterns at the fundamental frequency in the XY, XZ, YZ cut, with both horizontal and vertical receiver antenna polarization. The rotator was stepped in five degrees to record the radiation pattern in 360 degrees.

The DUT with coordinate system under the radiated measurements is shown in Figure 83. In the XY cut the rotation starts from the X-axis, while in the XZ and YZ cuts rotation starts from the Z-axis.

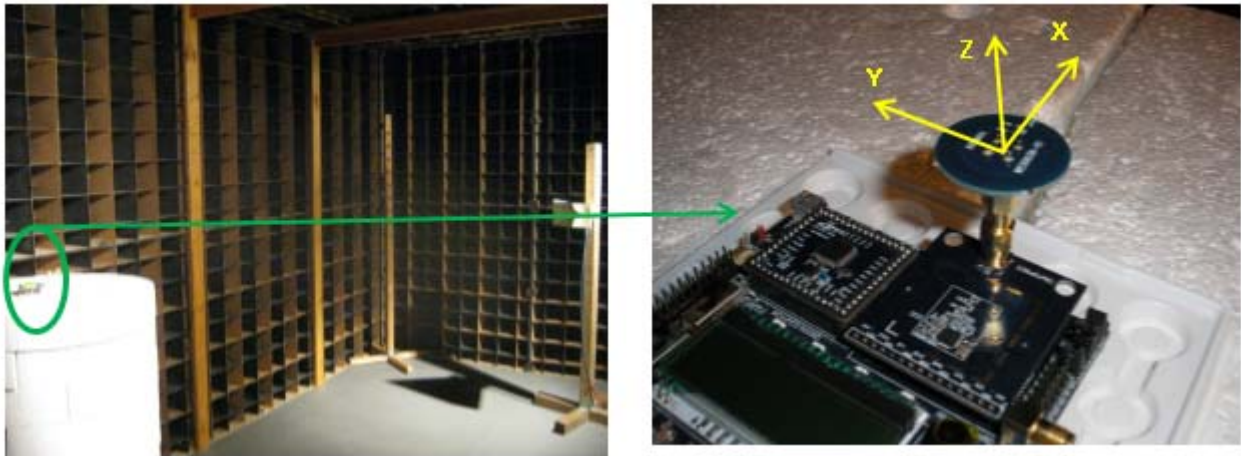


Figure 83. DUT in the Antenna Chamber

The measured radiation patterns (antenna gain in dBi) are shown in the following six figures (Figure 84–Figure 89).

**Radiation Pattern in dBi, 434MHz Panic ILA
XYV**

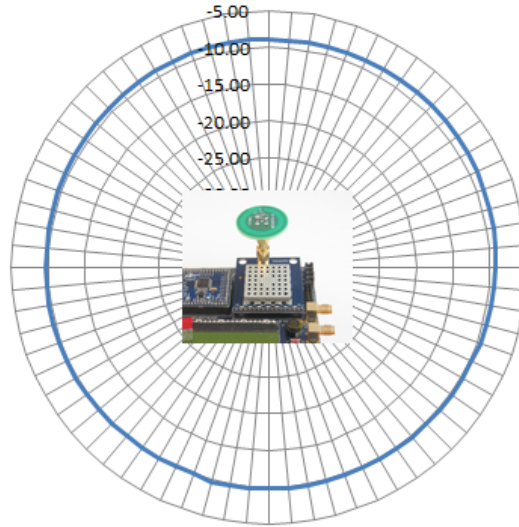


Figure 84. Radiation Pattern in the XY Cut with Vertical Receiver Antenna Polarization

**Radiation Pattern in dBi, 434MHz Panic ILA
XYH**

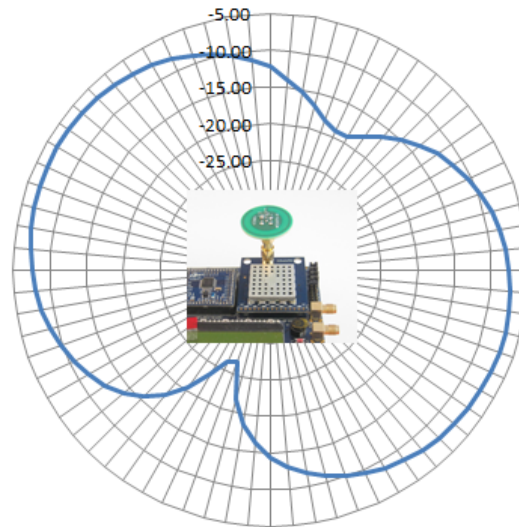


Figure 85. Radiation Pattern in the XY Cut with Horizontal Receiver Antenna Polarization

**Radiation Pattern in dBi, 434MHz Panic ILA
XZV**

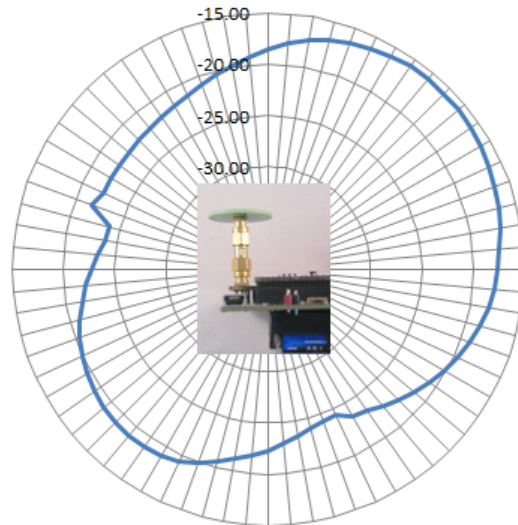


Figure 86. Radiation Pattern in the XZ Cut with Vertical Receiver Antenna Polarization

**Radiation Pattern in dBi, 434MHz Panic ILA
XZH**

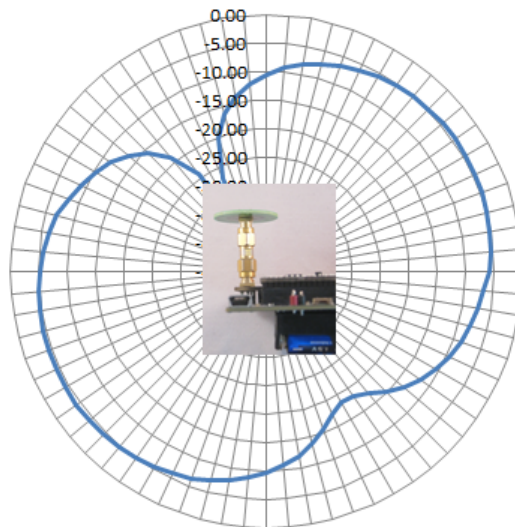


Figure 87. Radiation Pattern in the XZ Cut with Horizontal Receiver Antenna Polarization

**Radiation Pattern in dBi, 434MHz Panic ILA
YZV**

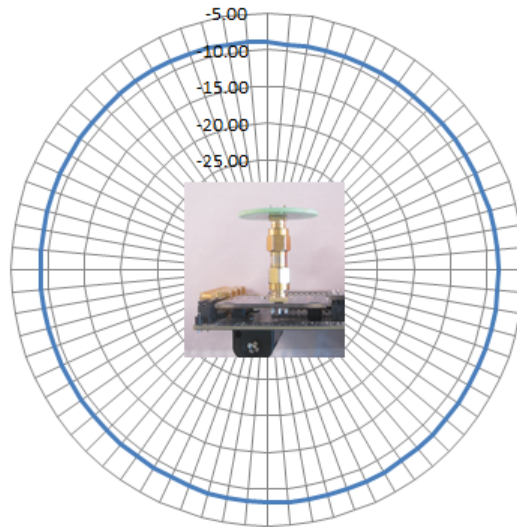


Figure 88. Radiation Pattern in the YZ Cut with Vertical Receiver Antenna Polarization

**Radiation Pattern in dBi, 434MHz Panic ILA
YZH**

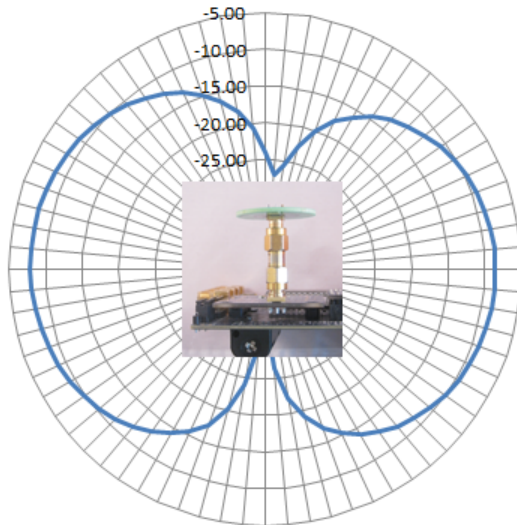


Figure 89. Radiation Pattern in the YZ Cut with Horizontal Receiver Antenna Polarization

7.4. Radiated Harmonics (WES0076-01-APL434P-01)

The radiated harmonics of the small ILA antenna were also measured in an antenna chamber using the 4455-PCE10D434 Pico Board connected through a male-to-male SMA transition with the WMB-930 Wireless Motherboard driving the Pico Board. The 4455-PCE10D434 Pico Board is set to a power state of 0x4F and a V_{DD} of ~2.9 V (two AA batteries) to deliver ~9 dBm, as Figure 82 shows. The maximum radiated power levels, up to the 10th harmonic, were measured in the XY, XZ, and YZ cut, with both horizontal and vertical polarized receiver antenna. The results are shown in the following EIRP table (Table 7) together with the corresponding standard limits.

The small sized panic button ILA antenna driven by the Si4455/60 class E match complies with the ETSI harmonic regulations.

Table 7. Radiated Harmonics, Panic Button ILA Antenna Driven by the Reduced Power (~+9 dBm) 4455-PCE10D434 Pico Board and by the WMB-930 Wireless Motherboard

Cut.	Pol.	Freq.	f [MHz]	ETSI limit in EIRP [dBm]	Measured radiated power in EIRP [dBm]	Margin [dB]
XY	V	Fund.	434	12.14	0.18	12.0
XY	V	2 nd	868	-33.88	-71.83	37.9
XY	V	3 rd	1302	-27.86	-70.36	42.5
XY	V	4 th	1736	-27.86	-44.63	16.8
XY	V	5 th	2170	-27.86	-38.37	10.5
XY	V	6 th	2604	-27.86	-42.26	14.4
XY	V	7 th	3038	-27.86	-46.96	19.1
XY	V	8 th	3472	-27.86	-44.19	16.3
XY	V	9 th	3906	-27.86	-48.55	20.7
XY	V	10 th	4340	-27.86	-39.99	12.1
XY	H	Fund.	434	12.14	2.52	9.6
XY	H	2 nd	868	-33.88	-70.00	36.1
XY	H	3 rd	1302	-27.86	-70.10	42.2
XY	H	4 th	1736	-27.86	-49.32	21.5
XY	H	5 th	2170	-27.86	-43.82	16.0
XY	H	6 th	2604	-27.86	-43.18	15.3
XY	H	7 th	3038	-27.86	-46.17	18.3
XY	H	8 th	3472	-27.86	-45.91	18.1
XY	H	9 th	3906	-27.86	-48.67	20.8

Table 7. Radiated Harmonics, Panic Button ILA Antenna Driven by the Reduced Power (~+9 dBm) 4455-PCE10D434 Pico Board and by the WMB-930 Wireless Motherboard(Continued)

Cut.	Pol.	Freq.	f [MHz]	ETSI limit in EIRP [dBm]	Measured radiated power in EIRP [dBm]	Margin [dB]
XY	H	10 th	4340	-27.86	-42.94	15.1
XZ	V	Fund.	434	12.14	-6.74	18.9
XZ	V	2 nd	868	-33.88	-66.31	32.4
XZ	V	3 rd	1302	-27.86	-70.01	42.2
XZ	V	4 th	1736	-27.86	-48.79	20.9
XZ	V	5 th	2170	-27.86	-39.23	11.4
XZ	V	6 th	2604	-27.86	-41.79	13.9
XZ	V	7 th	3038	-27.86	-44.83	17.0
XZ	V	8 th	3472	-27.86	-45.04	17.2
XZ	V	9 th	3906	-27.86	-49.40	21.5
XZ	V	10 th	4340	-27.86	-35.75	7.9
XZ	H	Fund.	434	12.14	4.78	7.4
XZ	H	2 nd	868	-33.88	-68.28	34.4
XZ	H	3 rd	1302	-27.86	-70.18	42.3
XZ	H	4 th	1736	-27.86	-47.23	19.4
XZ	H	5 th	2170	-27.86	-39.56	11.7
XZ	H	6 th	2604	-27.86	-36.85	9.0
XZ	H	7 th	3038	-27.86	-44.51	16.7
XZ	H	8 th	3472	-27.86	-42.95	15.1
XZ	H	9 th	3906	-27.86	-48.81	21.0
XZ	H	10 th	4340	-27.86	-38.98	11.1
YZ	V	Fund.	434	12.14	0.86	11.3
YZ	V	2 nd	868	-33.88	-64.74	30.9
YZ	V	3 rd	1302	-27.86	-69.85	42.0

Table 7. Radiated Harmonics, Panic Button ILA Antenna Driven by the Reduced Power (~+9 dBm) 4455-PCE10D434 Pico Board and by the WMB-930 Wireless Motherboard(Continued)

Cut.	Pol.	Freq.	f [MHz]	ETSI limit in EIRP [dBm]	Measured radiated power in EIRP [dBm]	Margin [dB]
YZ	V	4 th	1736	-27.86	-47.41	19.5
YZ	V	5 th	2170	-27.86	-42.35	14.5
YZ	V	6 th	2604	-27.86	-44.16	16.3
YZ	V	7 th	3038	-27.86	-45.82	18.0
YZ	V	8 th	3472	-27.86	-41.54	13.7
YZ	V	9 th	3906	-27.86	-50.99	23.1
YZ	V	10 th	4340	-27.86	-40.67	12.8
YZ	H	Fund.	434	12.14	1.10	11.0
YZ	H	2 nd	868	-33.88	-69.15	35.3
YZ	H	3 rd	1302	-27.86	-69.75	41.9
YZ	H	4 th	1736	-27.86	-47.35	19.5
YZ	H	5 th	2170	-27.86	-43.16	15.3
YZ	H	6 th	2604	-27.86	-41.12	13.3
YZ	H	7 th	3038	-27.86	-50.38	22.5
YZ	H	8 th	3472	-27.86	-45.32	17.5
YZ	H	9 th	3906	-27.86	-50.73	22.9
YZ	H	10 th	4340	-27.86	-37.41	9.5

7.5. Range Test (WES0076-01-APL434P-01)

The available range was measured using the Range Test Demo. This application is supplied with the standard development kits for EZRadioPRO®. The target of this measurement is to find the distance between the transceivers where the unidirectional PER (Packet Error Rate, number of lost packets) is not more than 1% at each side with ten byte packet length. The GPS coordinates have been recorded for each spot. The distance between the spots has been measured using Google Maps, and results are shown in meters. The range was tested between two identical units with the WMB-930 Wireless Motherboard, 4460-PCE10D434 Pico Board and the DUT (as shown in Figure 80) held by the users hand. During the tests the 4460-PCE10D434 is set to either +10 dBm or 0 dBm power state. The nominal +10 dBm power setting (state of 0x2D) is valid at 3.3 V V_{DD} only. At 3 V V_{DD} , supplied by the two AA batteries, the power level is lower, around +8.8 dBm. At the nominal 0 dBm setting (state of 0x07) the power decrease is negligible at 3 V V_{DD} .

The range was tested in a flat land area without obstacles.

During the range test, the following settings were used:

- Set 1: Txpow=10 dBm (~8.8 dBm @ 3 V V_{DD}), 40 kbps, 20 kHz dev., RXBW=82.64 kHz (sens ~-105.5 dBm)
- Set 2: Txpow=10 dBm (~8.8 dBm @ 3 V V_{DD}), 100 kbps, 50 kHz dev., RXBW=206.12 kHz (sens ~-100.7 dBm)
- Set 3: Txpow=0 dBm, 2.4 kbps, 2.4 kHz dev., RXBW=25.77 kHz (sens ~-115.9 dBm)

Using the above settings (Set 1, Set 2, and Set 3) the following range tests are done here:

1. Range measurement with the PANIC BUTTON ILA Antenna Boards—The antenna boards are HORIZONTALLY polarized and the X-axes are facing each other (i.e., normal usage position). The applied setting is "Set 1".
2. Range measurement with the PANIC BUTTON ILA Antenna Boards—The antenna boards are VERTICALLY polarized and the X-axes are facing each other (i.e., normal usage position). The applied setting is "Set 1".
3. Range measurement with the PANIC BUTTON ILA Antenna Boards—The antenna boards are VERTICALLY polarized and the X-axes are facing each other (i.e., normal usage position). The applied setting is "Set 2".
4. Range measurement with the PANIC BUTTON ILA Antenna Boards—The antenna boards are VERTICALLY polarized and the X-axes are facing each other (i.e., normal usage position). The applied setting is "Set 3".
5. Range measurement with the PANIC BUTTON ILA Antenna Boards—The antenna boards are VERTICALLY polarized and boards are facing each other in their direction of maximum radiation. The applied setting is "Set 1".
6. Reference range measurement with two 434 MHz REFERENCE MONOPOLE (ANT-433-HETH from Linx Technologies) in VERTICAL polarization using the setting denoted by "Set 1".
7. Reference range measurement with two 434 MHz REFERENCE MONOPOLE (ANT-433-HETH from Linx Technologies) in VERTICAL polarization using the setting denoted by "Set 3".
8. Reference range measurement with a 434 MHz REFERENCE MONOPOLE (ANT-433-HETH from Linx Technologies) in HORIZONTAL polarization using the setting denoted by "Set 1".

The measurement results are summarized in Figure 90.

Note: These range test results are valid with the above configuration and with moderate hand effect. In normal battery-operated, small push-button applications, where there is no large GND (motherboard) close to the antenna and where the antenna is usually very close to the user's hand, the achievable range is most likely much shorter.

The indoor range test was not performed, due to the lack of a large enough building. But from the TX power and sensitivity data, an indoor range estimation can be given if one assumes a propagation factor of 4.5, which is a typical value in normal office environments. Use the Silicon Labs' range calculator, which can be found here:

<http://www.silabs.com/support/pages/document-library.aspx?p=Wireless&f=EZRadioPRO&pn=Si4460>

Assuming -8.8 dBi antenna gain (front direction, X-axis facing) and the setting "Set 1" (40 kbps, 1% PER, +8.8 dBm), the estimated indoor range is 58 m, as shown in Figure 91. To the maximum antenna gain direction, the indoor range between two identical units is ~92 m.

		Set1	10dBm	40kbps	+/-20kHz	GPS		Distance [m]
		Set2	10dBm	100kbps	+/-50kHz	N	E	
		Set3	0dBm	2.4kbps	+/-2.4kHz			
F	Panic Button ILA				Base	47.152880°	19.180930°	0.0
Panic Button ILA (WES0076)	H pol; Norm. direction					GPS		387.0
						N	E	
	1	Set1	10dBm	40kbps	+/-20kHz	47.155060°	19.176940°	
	V pol; Norm. direction					GPS		842.4 426.9 786.0
						N	E	
	2	Set1	10dBm	40kbps	+/-20kHz	47.158860°	19.174090°	
	3	Set2	10dBm	100kbps	+/-50kHz	47.155360°	19.176620°	
	4	Set3	0dBm	2.4kbps	+/-2.4kHz	47.158250°	19.174170°	
	Max. direction: XZH 240°					GPS		1040.8
						N	E	
5	Set1	10dBm	40kbps	+/-20kHz	47.160870°	19.173760°		
ANT-433-HETH from LINX	V pol; Norm. direction					GPS		1778.7 1188.2
						N	E	
	6	Set1	10dBm	40kbps	+/-20kHz	47.167850°	19.172640°	
	7	Set3	0dBm	2.4kbps	+/-2.4kHz	47.162300°	19.17351	
	H pol; Norm. direction					GPS		1315.3
						N	E	
8	Set1	10dBm	40kbps	+/-20kHz	47.163520°	19.173330°		

Figure 90. Outdoor Range Test Results with Two Identical ILA Panic Button Antenna Boards Driven by Reduced Power 4460-PCE10D434 Pico Boards and WMB-930 Wireless Motherboards. Range Test Results with Reference Monopoles are Also Shown.

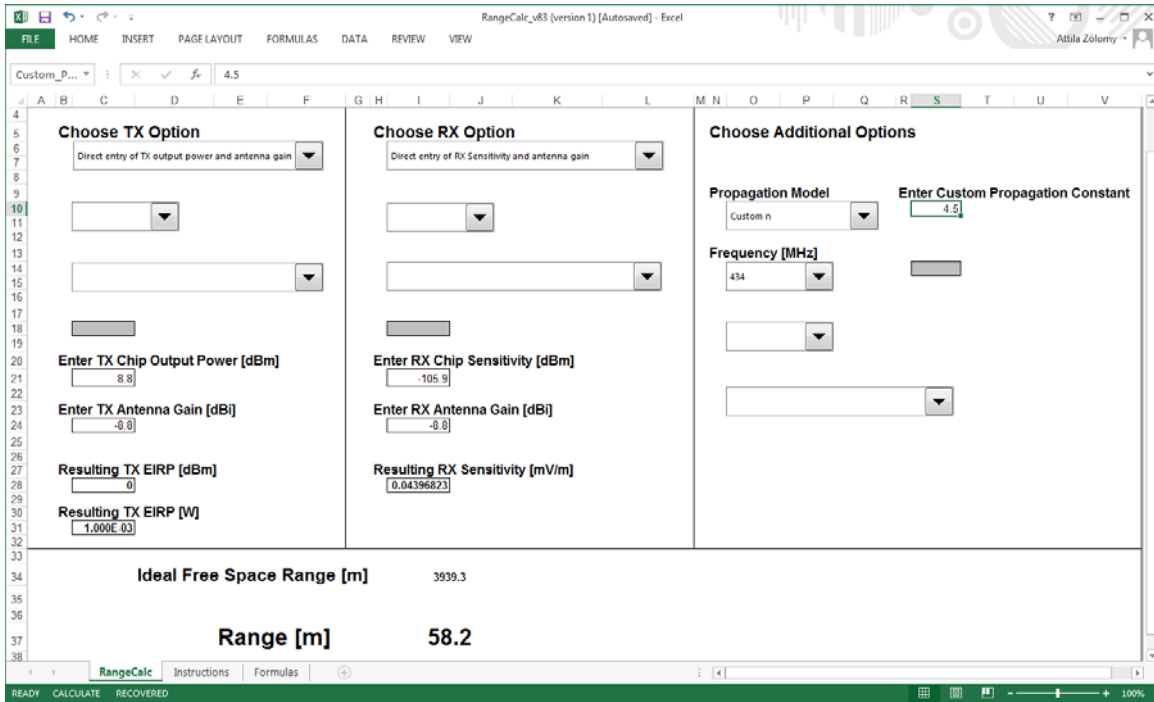


Figure 91. Indoor Range Estimation with Two Identical ILA Panic Button Antenna Boards Driven by Reduced Power 4460-PCE10D434 Pico Boards and WMB-930 Wireless Motherboards

8. Printed Meander Monopole (WES0077-01-APN434D-01)

For the Printed Meander Monopole, an external matching network (shown in Figure 92) is required at the antenna input.

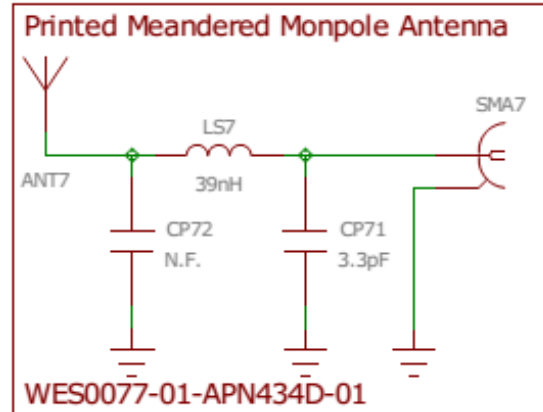


Figure 92. External Matching Network at 434 M for the Printed Meander Antenna

The antenna is shown in Figure 93.



Figure 93. Printed Meander Monopole Antenna

8.1. Antenna Impedance (WES0077-01-APN434D-01)

The measurement setup is shown in Figure 94. The antenna board is connected to the 4455-PCE10D434 Pico Board through a male-to-male SMA transition with the WMB-930 Wireless Motherboard driving the Pico Board.

During the range test, the user's hand holds the motherboard. Typical hand position is shown in Figure 95.



**Figure 94. DUT in the Impedance Measurement Setup
(Meander Monopole Antenna Board [WES0077])**

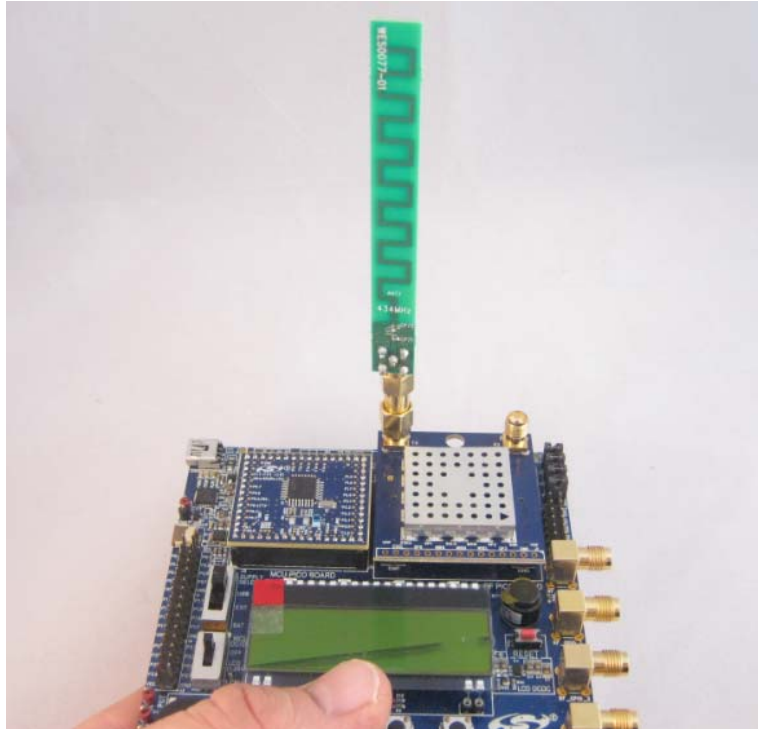


Figure 95. Typical Hand Effect on the Main Board During Impedance and Range Measurement (Printed Meander Antenna Board [WES0077])

The measured impedance of the antenna with its external matching network is shown in Figure 96 (up to 1.5 GHz) with motherboard hand effect.

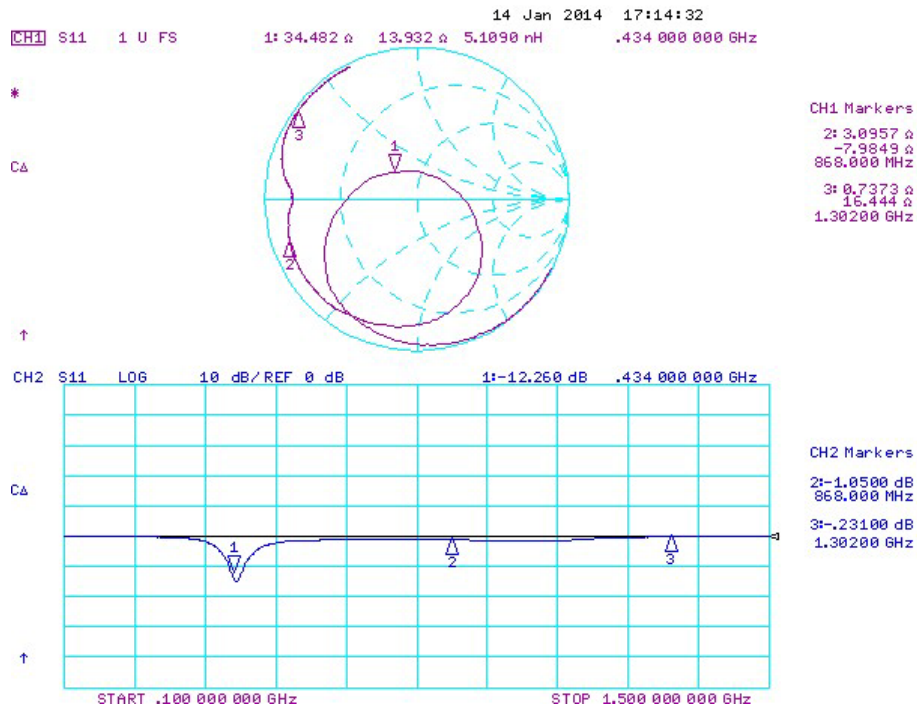


Figure 96. Measured Impedance up to 1.5 GHz with Hand Effect on the Main Board

8.2. Antenna Gain (WES0077-01-APN434D-01)

The antenna gain is calculated from the measured radiated power at the fundamental and from the delivered power to the antenna. In the radiation measurement, the 4455-PCE10D434 Pico Board is set to reduced (~+9 dBm) power level, and the entire setup is fed by two AA batteries. The conducted SA measurement result of the 4455-PCE10D434 Pico Board in this reduced (~10 dBm) power state is shown in Figure 97. This method can be effectively applied because the S11 of the antenna is much better than -10 dB, so the reflection is negligible.

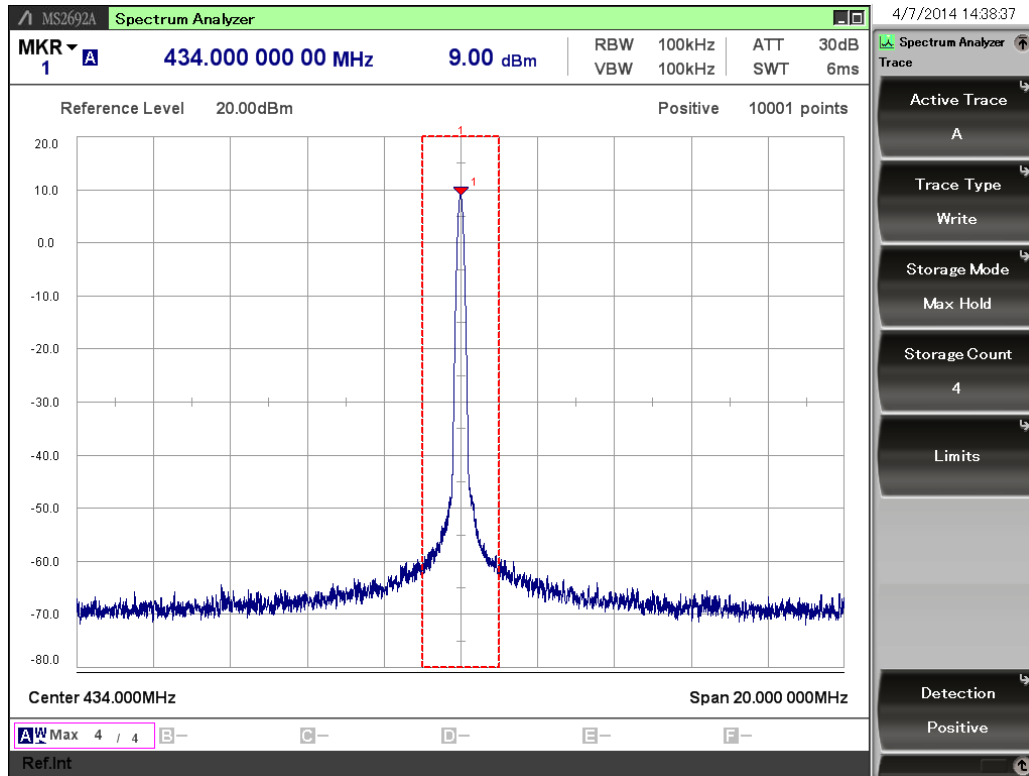


Figure 97. Conducted Measurement Result, 4461-PCE10D434 in Reduced (~10 dBm) Power State

The measured radiated power maximum is at the XY cut (Table 8). It is around 12.1 dBm EIRP, so the maximum gain number is ~3.1 dBi, as shown in Figure 98.

8.3. Radiation Patterns (WES0077-01-APN434D-01)

The radiation patterns of the printed meander antenna were measured in an antenna chamber using the 4455-PCE10D434 Pico Board connected through a male-to-male SMA transition with the WMB-930 Wireless Motherboard driving the Pico Board. Figure 99—Figure 104 show the radiation patterns at the fundamental frequency in the XY, XZ, and YZ cut, with both horizontal and vertical receiver antenna polarization. The rotator was stepped in five degrees to record the radiation pattern in 360 degrees.

The DUT with coordinate system under the radiated measurements is shown in Figure 98. In the XY cut the rotation starts from the X-axis, while in the XZ and YZ cuts rotation starts from the Z-axis.

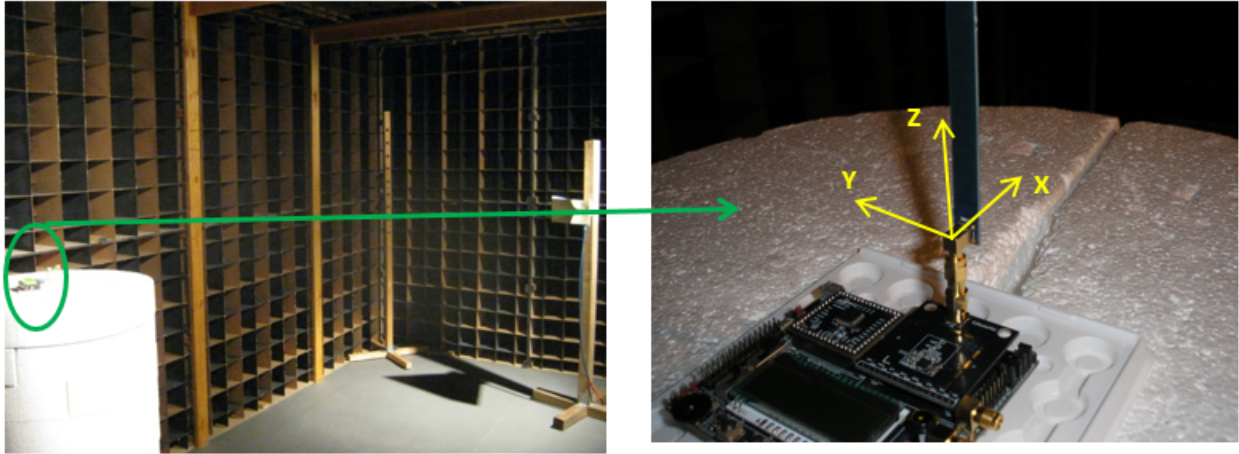


Figure 98. DUT in the Antenna Chamber

The measured radiation patterns (antenna gain in dBi) are shown in the following six figures (Figure 99–Figure 104).

**Radiation Pattern in dBi, 434MHz Meander
Monopole XYV**

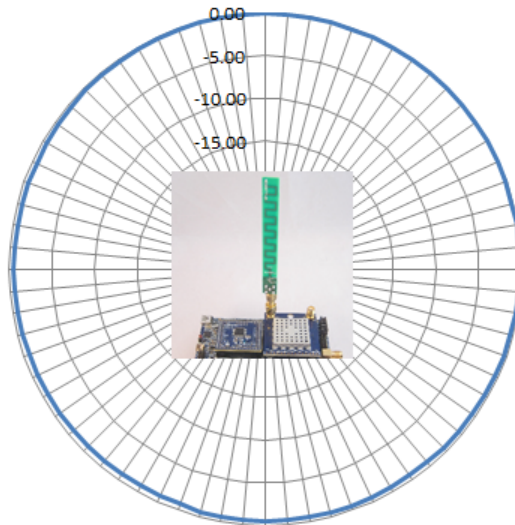


Figure 99. Radiation Pattern in the XY Cut with Vertical Receiver Antenna Polarization

**Radiation Pattern in dBi, 434MHz Meander
Monopole XYH**

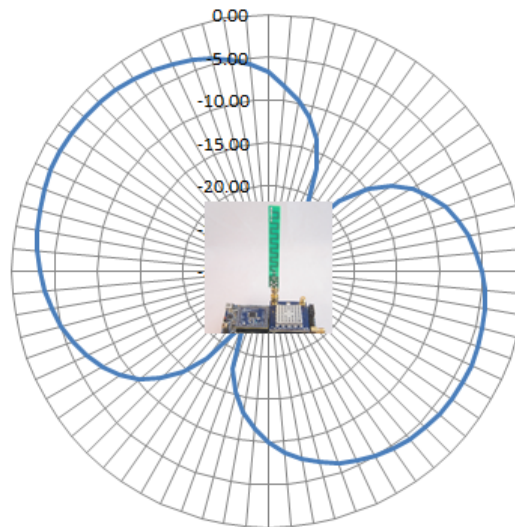


Figure 100. Radiation Pattern in the XY Cut with Horizontal Receiver Antenna Polarization

**Radiation Pattern in dBi, 434MHz Meander
Monopole XZV**

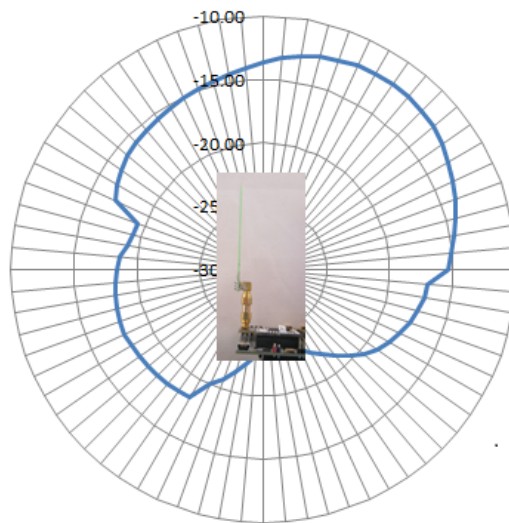


Figure 101. Radiation Pattern in the XZ Cut with Vertical Receiver Antenna Polarization

**Radiation Pattern in dBi, 434MHz Meander
Monopole XZH**

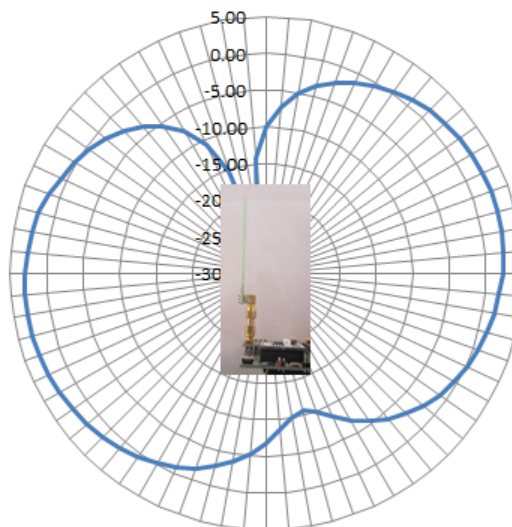


Figure 102. Radiation Pattern in the XZ Cut with Horizontal Receiver Antenna Polarization

**Radiation Pattern in dBi, 434MHz Meander
Monopole YZV**

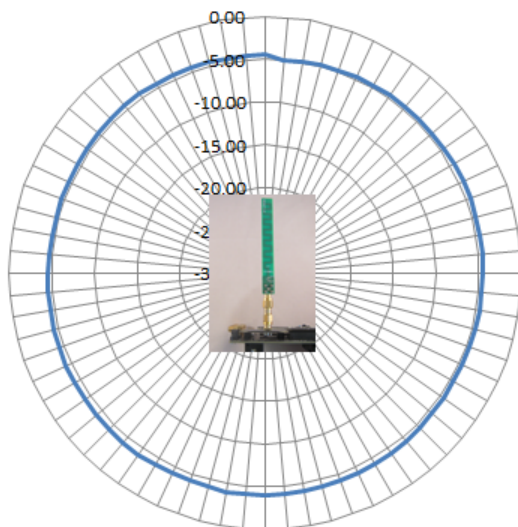


Figure 103. Radiation Pattern in the YZ Cut with Vertical Receiver Antenna Polarization

**Radiation Pattern in dBi, 434MHz Meander
Monopole YZH**

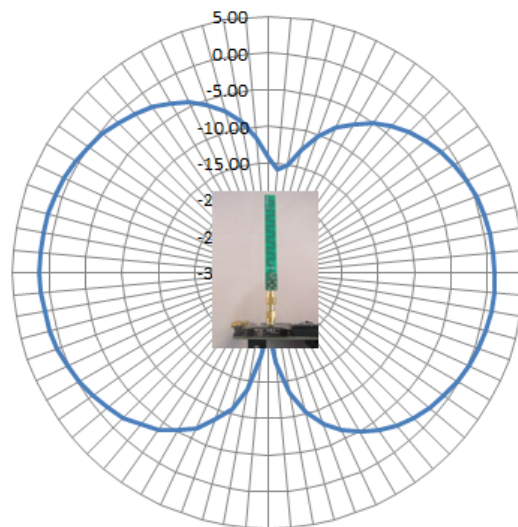


Figure 104. Radiation Pattern in the YZ Cut with Horizontal Receiver Antenna Polarization

8.4. Radiated Harmonics (WES0077-01-APN434D-01)

The radiated harmonics of the printed meander antenna were also measured in an antenna chamber using the 4455-PCE10D434 Pico Board connected through a male-to-male SMA transition with the WMB-930 Wireless Motherboard driving the Pico Board. The 4455-PCE10D434 Pico Board is set to a power state of 0x4F and a V_{DD} of ~2.9 V (two AA batteries) to deliver ~9 dBm, as Figure 97 shows. The maximum radiated power levels, up to the 10th harmonic, were measured in the XY, XZ, and YZ cut, with both horizontal and vertical polarized receiver antenna. The results are shown in the following EIRP table (Table 8) together with the corresponding standard limits.

The antenna is ETSI compliant.

Table 8. Radiated Harmonics, Printed Meander Antenna Board Driven by the Reduced Power (~+ 9 dBm) 4455-PCE10D434 and by the WMB-930 Wireless Motherboard

Cut.	Pol.	Freq.	f [MHz]	ETSI limit in EIRP [dBm]	Measured radiated power in EIRP [dBm]	Margin [dB]
XY	V	Fund.	434	12.14	9.01	3.1
XY	V	2 nd	868	-33.88	-70.44	36.6
XY	V	3 rd	1302	-27.86	-66.76	38.9
XY	V	4 th	1736	-27.86	-50.44	22.6
XY	V	5 th	2170	-27.86	-40.45	12.6
XY	V	6 th	2604	-27.86	-41.35	13.5
XY	V	7 th	3038	-27.86	-44.06	16.2
XY	V	8 th	3472	-27.86	-46.53	18.7
XY	V	9 th	3906	-27.86	-45.14	17.3
XY	V	10 th	4340	-27.86	-40.34	12.5
XY	H	Fund.	434	12.14	7.12	5.0
XY	H	2 nd	868	-33.88	-73.16	39.3
XY	H	3 rd	1302	-27.86	-67.18	39.3
XY	H	4 th	1736	-27.86	-53.85	26.0
XY	H	5 th	2170	-27.86	-47.10	19.2
XY	H	6 th	2604	-27.86	-40.03	12.2
XY	H	7 th	3038	-27.86	-43.65	15.8
XY	H	8 th	3472	-27.86	-48.29	20.4
XY	H	9 th	3906	-27.86	-45.51	17.7

Table 8. Radiated Harmonics, Printed Meander Antenna Board Driven by the Reduced Power (~+ 9 dBm) 4455-PCE10D434 and by the WMB-930 Wireless Motherboard(Continued)

Cut.	Pol.	Freq.	f [MHz]	ETSI limit in EIRP [dBm]	Measured radiated power in EIRP [dBm]	Margin [dB]
XY	H	10 th	4340	-27.86	-43.00	15.1
XZ	V	Fund.	434	12.14	-3.05	15.2
XZ	V	2 nd	868	-33.88	-68.68	34.8
XZ	V	3 rd	1302	-27.86	-67.55	39.7
XZ	V	4 th	1736	-27.86	-51.86	24.0
XZ	V	5 th	2170	-27.86	-41.82	14.0
XZ	V	6 th	2604	-27.86	-36.46	8.6
XZ	V	7 th	3038	-27.86	-40.66	12.8
XZ	V	8 th	3472	-27.86	-45.41	17.6
XZ	V	9 th	3906	-27.86	-45.06	17.2
XZ	V	10 th	4340	-27.86	-36.05	8.2
XZ	H	Fund.	434	12.14	12.11	0.0
XZ	H	2 nd	868	-33.88	-71.04	37.2
XZ	H	3 rd	1302	-27.86	-68.00	40.1
XZ	H	4 th	1736	-27.86	-52.25	24.4
XZ	H	5 th	2170	-27.86	-40.98	13.1
XZ	H	6 th	2604	-27.86	-35.21	7.3
XZ	H	7 th	3038	-27.86	-43.29	15.4
XZ	H	8 th	3472	-27.86	-44.10	16.2
XZ	H	9 th	3906	-27.86	-46.27	18.4
XZ	H	10 th	4340	-27.86	-39.44	11.6
YZ	V	Fund.	434	12.14	5.04	7.1
YZ	V	2 nd	868	-33.88	-67.86	34.0

Table 8. Radiated Harmonics, Printed Meander Antenna Board Driven by the Reduced Power (~+ 9 dBm) 4455-PCE10D434 and by the WMB-930 Wireless Motherboard(Continued)

Cut.	Pol.	Freq.	f [MHz]	ETSI limit in EIRP [dBm]	Measured radiated power in EIRP [dBm]	Margin [dB]
YZ	V	3 rd	1302	-27.86	-66.01	38.2
YZ	V	4 th	1736	-27.86	-50.03	22.2
YZ	V	5 th	2170	-27.86	-43.88	16.0
YZ	V	6 th	2604	-27.86	-41.41	13.5
YZ	V	7 th	3038	-27.86	-42.86	15.0
YZ	V	8 th	3472	-27.86	-41.84	14.0
YZ	V	9 th	3906	-27.86	-50.15	22.3
YZ	V	10 th	4340	-27.86	-40.73	12.9
YZ	H	Fund.	434	12.14	10.29	1.8
YZ	H	2 nd	868	-33.88	-70.64	36.8
YZ	H	3 rd	1302	-27.86	-69.30	41.4
YZ	H	4 th	1736	-27.86	-49.32	21.5
YZ	H	5 th	2170	-27.86	-44.21	16.3
YZ	H	6 th	2604	-27.86	-36.19	8.3
YZ	H	7 th	3038	-27.86	-44.30	16.4
YZ	H	8 th	3472	-27.86	-45.79	17.9
YZ	H	9 th	3906	-27.86	-49.87	22.0
YZ	H	10 th	4340	-27.86	-37.49	9.6

8.5. Range Test(WES0077-01-APN434D-01)

The available range was measured using the Range Test Demo. This application is supplied with the standard development kits for EZRadioPRO®. The target of this measurement is to find the distance between the transceivers where the one-directional PER (Packet Error Rate, number of lost packets) is not more than 1% at each side with ten byte packet length. The GPS coordinates have been recorded for each spot. The distance between the spots has been measured using Google Maps, and results are shown in meters. The range was tested between two identical units with the WMB-930 Wireless Motherboard, 4460-PCE10D434 Pico Board, and the DUT (as shown in Figure 95) held by the users hand. During the test the 4460-PCE10D434 Pico Board is set to either a +10 dBm or 0 dBm power state.

The range was tested in a flat land area without obstacles.

During the range test, the following settings were used:

- Set 1: Txpow=10 dBm (~8.8 dBm @ 3 V V_{DD}), 40 kbps, 20 kHz dev., RXBW=82.64 kHz (sens ~-105.5 dBm)
- Set 2: Txpow=10 dBm (~8.8 dBm @ 3 V V_{DD}), 100 kbps, 50 kHz dev., RXBW=206.12 kHz (sens ~-100.7 dBm)
- Set 3: Txpow=0 dBm, 2.4 kbps, 2.4 kHz dev., RXBW=25.77 kHz (sens ~-115.9 dBm)

Using the above settings (Step 1, Step 2, and Step 3) the following range tests are done here:

1. Range measurement with the PRINTED MEANDER Antenna Boards—The antenna boards are HORIZONTALLY polarized and the X-axes are facing each other (i.e., normal usage position). The applied setting is "Set 1".
2. Range measurement with the PRINTED MEANDER Antenna Boards—The antenna boards are VERTICALLY polarized and the X-axes are facing each other (i.e., normal usage position). The applied setting is "Set 1".
3. Range measurement with the PRINTED MEANDER Antenna Boards—The antenna boards are VERTICALLY polarized and the X-axes are facing each other (i.e., normal usage position). The applied setting is "Set 2".
4. Range measurement with the PRINTED MEANDER Antenna Boards—The antenna boards are VERTICALLY polarized and the X-axes are facing each other (i.e., normal usage position). The applied setting is "Set 3".
5. Range measurement with the PRINTED MEANDER Antenna Boards—The antenna boards are VERTICALLY polarized and the boards are facing each other in their direction of maximum radiation. The applied setting is "Set 1".
6. Reference range measurement with two 434 MHz REFERENCE MONOPOLE (ANT-433-HETH from Linx Technologies) in VERTICAL polarization using the setting denoted by "Set 1".
7. Reference range measurement with two 434 MHz REFERENCE MONOPOLE (ANT-433-HETH from Linx Technologies) in VERTICAL polarization using the setting denoted by "Set 3".
8. Reference range measurement with a 434 MHz REFERENCE MONOPOLE (ANT-433-HETH from Linx Technologies) in HORIZONTAL polarization using the setting denoted by "Set 1".

The measurement results are summarized in Figure 105.

The indoor range was not measured, due to the lack of a large enough building. But from the TX power and sensitivity data, an indoor range estimation can be given if one assumes an indoor propagation factor of 4.5, which is a typical value in normal office environments. Use the Silicon Labs' range calculator, which can be found here:

<http://www.silabs.com/support/pages/document-library.aspx?p=Wireless&f=EZRadioPRO&pn=Si4460>

Assuming 0 dBi antenna gain (front direction) and the setting "Set 1" (40 kbps, 1% PER, +8.8 dBm), the estimated indoor range is 143 m, as shown in Figure 106. To the maximum antenna gain direction the indoor range between two identical units is ~197 m.

						GPS		Distance [m]																		
						N	E																			
<table border="1"> <tr><td>Set1</td><td>10dBm</td><td>40kbps</td><td colspan="2">+/-20kHz</td><td></td></tr> <tr><td>Set2</td><td>10dBm</td><td>100kbps</td><td colspan="2">+/-50kHz</td><td></td></tr> <tr><td>Set3</td><td>0dBm</td><td>2.4kbps</td><td colspan="2">+/-2.4kHz</td><td></td></tr> </table>						Set1	10dBm	40kbps	+/-20kHz			Set2	10dBm	100kbps	+/-50kHz			Set3	0dBm	2.4kbps	+/-2.4kHz					
Set1	10dBm	40kbps	+/-20kHz																							
Set2	10dBm	100kbps	+/-50kHz																							
Set3	0dBm	2.4kbps	+/-2.4kHz																							
F	Meandered Monopole				Base	47.152880° 19.180930°		0.0																		
Meandered Monopole (WES0077)			H pol; Norm. direction																							
			GPS																							
			N E																							
	31	Set1	10dBm	40kbps	+/-20kHz	47.161730°	19.173580°	1130.2																		
	32	Set2	10dBm	100kbps	+/-50kHz	47.158920°	19.174070°	848.6																		
	33	Set3	0dBm	2.4kbps	+/-2.4kHz	47.161590°	19.173620°	1115.1																		
			V pol; Norm. direction																							
			GPS																							
			N E																							
	34	Set1	10dBm	40kbps	+/-20kHz	47.163830°	19.173250°	1349.0																		
Meandered Monopole (WES0077)			Max. direction: XZH 260°																							
			GPS																							
			N E																							
	35	Set1	10dBm	40kbps	+/-20kHz	47.165530°	19.173000°	1529.1																		
			V pol; Norm. direction																							
		GPS																								
		N E																								
36	Set1	10dBm	40kbps	+/-20kHz	47.167850°	19.172640°	1778.7																			
37	Set3	0dBm	2.4kbps	+/-2.4kHz	47.162300°	19.17351	1188.2																			
ANT-433-HETH from LINX			H pol; Norm. direction																							
			GPS																							
			N E																							
38	Set1	10dBm	40kbps	+/-20kHz	47.163520°	19.173330°	1315.3																			

Figure 105. Outdoor Range Test Results with Two Identical Printed Meander Monopole Antenna Boards Driven by Reduced Power 4460-PCE10D434 Pico Boards and WMB-930 Wireless Motherboards. Range Test Results with Reference Monopoles are Also Shown.

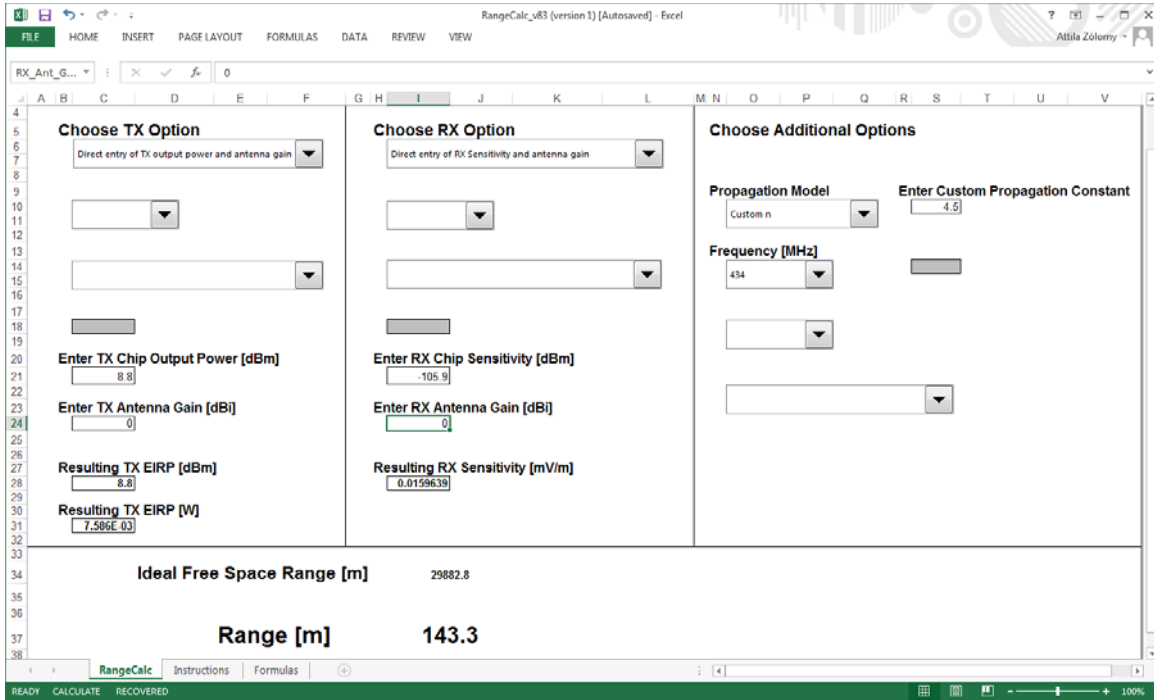


Figure 106. Indoor Range Estimation with Two Identical Printed Meander Monopole Antennas with the Reduced Power (~+8.8 dBm) 4460-PCE10D434 Pico Board Driven by the WMB-930 Wireless Motherboard

9. Small Sized Printed ILA antenna (WES0078-01-APL434S-01)

The Small Sized Printed ILA antenna has the following characteristics:

- The distance between the antenna trace outer edge and the PCB cutting edge is 1.5 mm.
- The sized of the separated PCB antenna area is 15x15 mm.
- An external matching network (shown in Figure 107) is required at the antenna input.

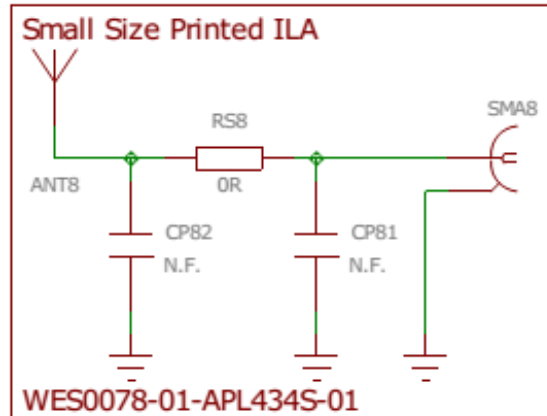


Figure 107. External Antenna Matching Network at 434 M for the Small ILA Antenna

The antenna is shown in Figure 108.

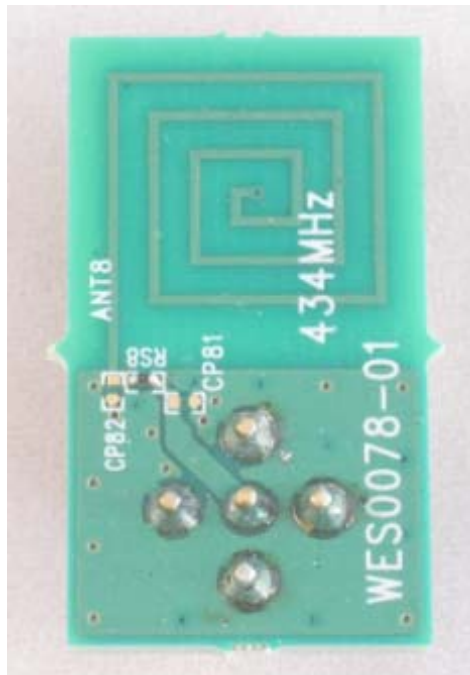
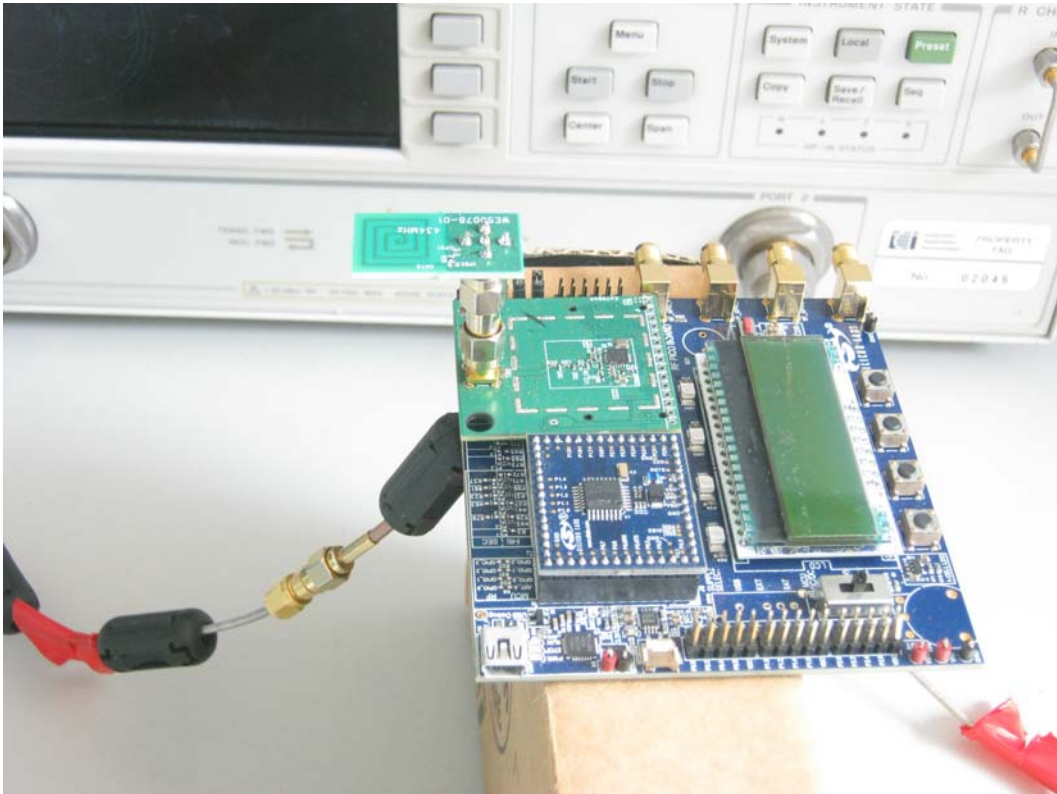


Figure 108. Small Sized Printed ILA Antenna

9.1. Antenna Impedance (WES0078-01-APL434S-01)

The impedance measurement setup is shown in Figure 109. The antenna board is connected to the 4455-PCE10D434 Pico Board through a male-to-male SMA transition with the WMB-930 Wireless Motherboard driving the Pico Board.

During the range test, the user's hand holds the motherboard. A typical hand position is shown in Figure 110.



**Figure 109. DUT in the Impedance Measurement Setup
(Small Sized ILA Antenna Board [WES0078])**

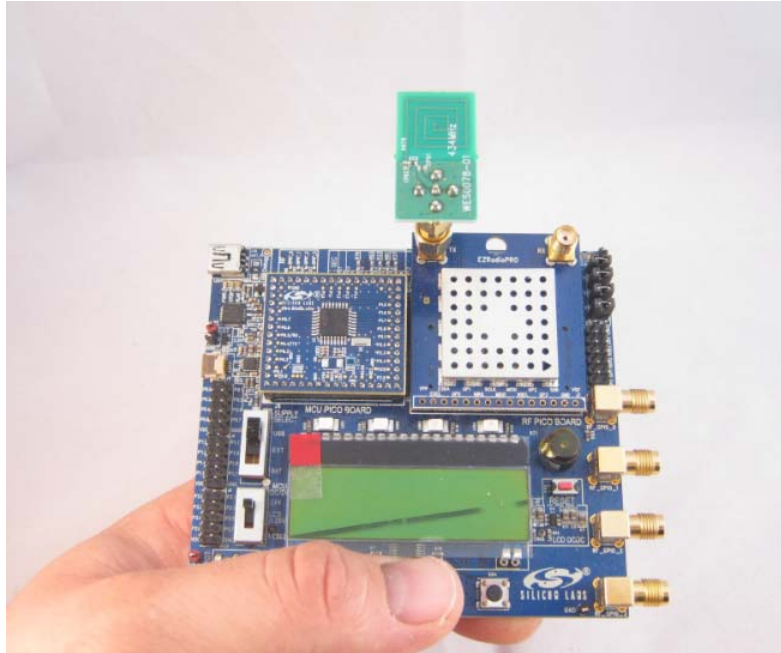


Figure 110. Typical Hand Effect on the Main Board During Impedance and Range Measurement (Small Sized Printed ILA Antenna Board [WES0078])

The measured impedance of the antenna with its external matching network is shown in Figure 111 (up to 1.5 GHz) with motherboard hand effect.

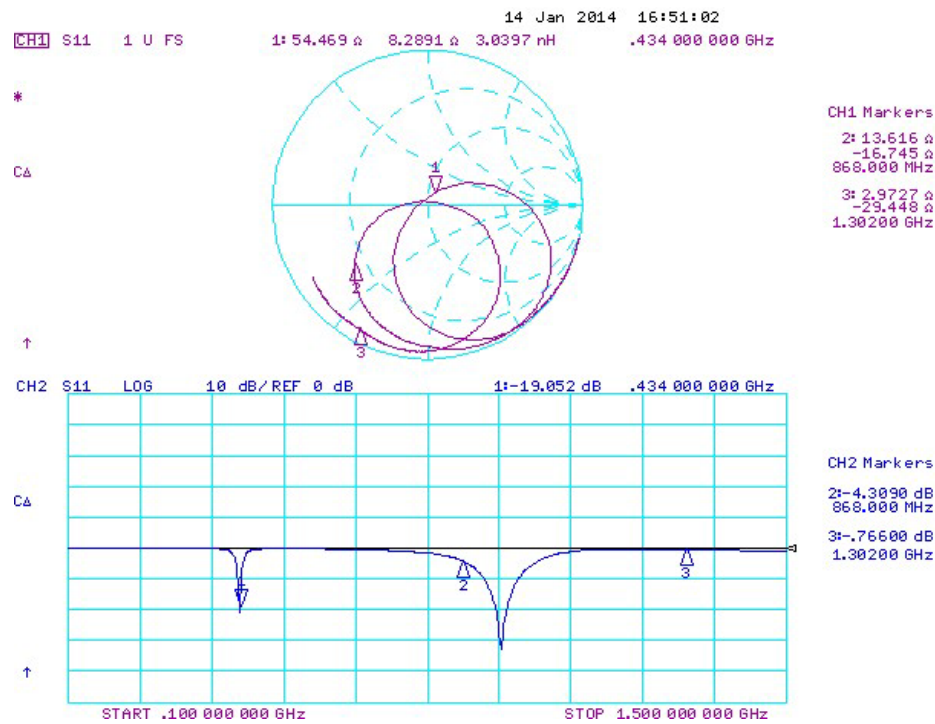


Figure 111. Measured Impedance up to 1.5 GHz with Hand Effect on the Main Board

9.2. Antenna Gain (WES0078-01-APL434S-01)

The antenna gain is calculated from the measured radiated power at the fundamental and from the delivered power to the antenna. In the radiation measurement, the 4455-PCE10D434 Pico Board is set to reduced (~+9 dBm) power level and the entire setup is fed by two AA batteries. The conducted SA measurement result of the 4455-PCE10D434 Pico Board in this reduced (~10 dBm) power state is shown in Figure 112. This method can be effectively applied because the S11 of the antenna is much better than -10 dB so the reflection is negligible.

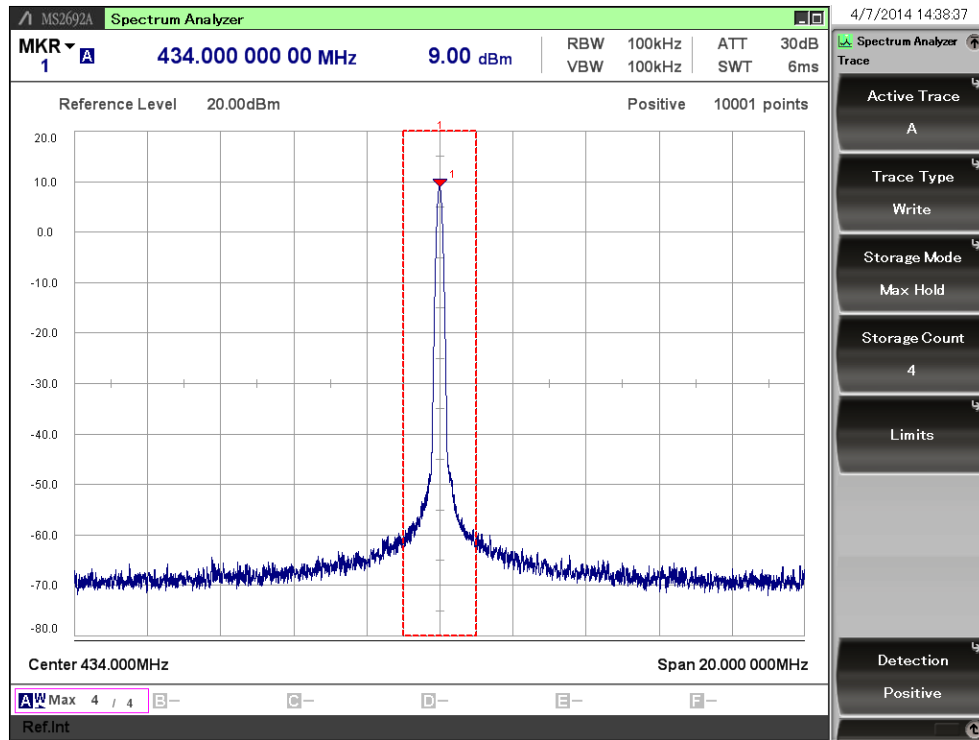


Figure 112. Conducted Measurement Result, 4455-PCE10D434 in a Reduced (~+9 dBm) Power Level: the State is 0x4F, and V_{DD} is ~2.9 V (Two AA Batteries)

The measured radiated power maximum is at the XZ cut (Table 9). It is around +0.5 dBm EIRP, so the maximum gain number is ~-8.5 dBi, as shown in Figure 116.

This gain number is surprisingly high for such a small antenna. It should be emphasized that in typical, small remote applications, the grounding environment and the strength of the hand effect is different. Without the SMA connector, the SMA male-male transition, the Pico Board, and the wireless motherboard, the achievable antenna gain is weaker. Fortunately, the typical application of the Small Sized ILA antenna is in dongles, where the presence of a large computer or laptop chassis supplies the ground and thus the gain improves.

9.3. Radiation Patterns (WES0078-01-APL434S-01)

The radiation patterns of the small sized printed ILA antenna were measured in an antenna chamber using the 4455-PCE10D434 Pico Board connected through a male-to-male SMA transition with the WMB-930 Wireless Motherboard driving the Pico Board. Figure 114—Figure 119 show the radiation patterns at the fundamental frequency in the XY, XZ, and YZ cut, with both horizontal and vertical receiver antenna polarization. The rotator was stepped in five degrees to record the radiation pattern in 360 degrees.

The DUT with coordinate system under the radiated measurements is shown in Figure 113. In the XY cut the rotation starts from the X-axis, while in the XZ and YZ cuts rotation starts from the Z-axis.

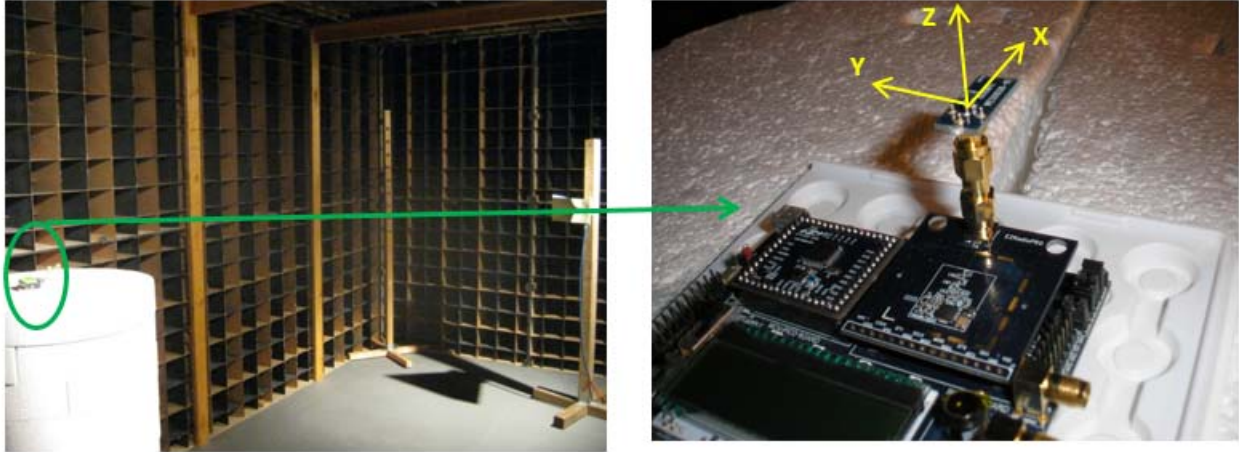


Figure 113. DUT in the Antenna Chamber

The measured radiation patterns (antenna gain in dBi) are shown in the following six figures (Figure 114–Figure 119).

**Radiation Pattern in dBi, Small 434MHz ILA
XYV**

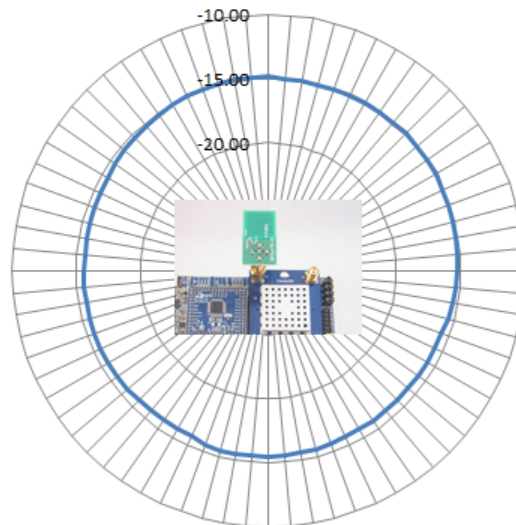


Figure 114. Radiation Pattern in the XY Cut with Vertical Receiver Antenna Polarization

**Radiation Pattern in dBi, Small 434MHz ILA
XYH**

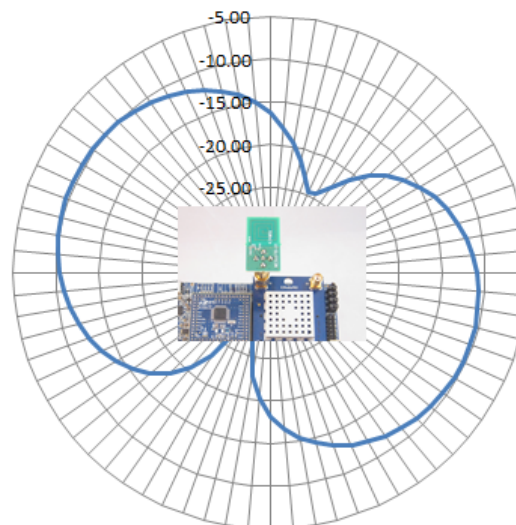


Figure 115. Radiation Pattern in the XY Cut with Horizontal Receiver Antenna Polarization

**Radiation Pattern in dBi, Small 434MHz ILA
XZV**

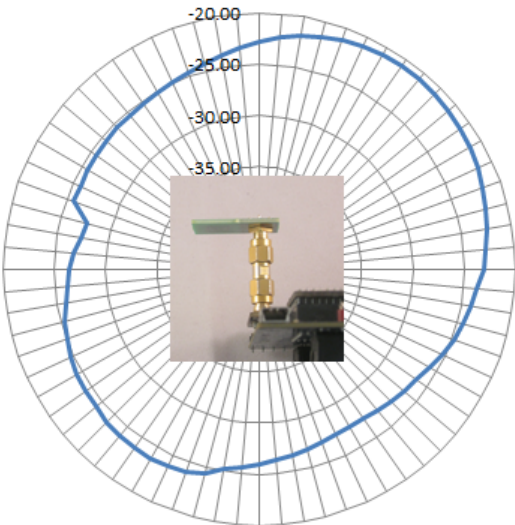


Figure 116. Radiation Pattern in the XZ Cut with Vertical Receiver Antenna Polarization

**Radiation Pattern in dBi, Small 434MHz ILA
XZH**

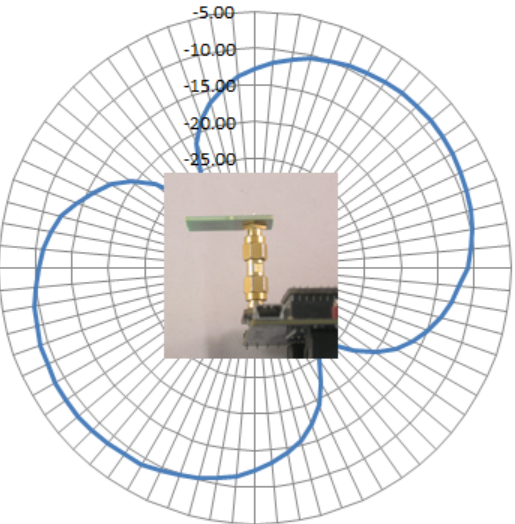


Figure 117. Radiation Pattern in the XZ Cut with Horizontal Receiver Antenna Polarization

**Radiation Pattern in dBi, Small 434MHz ILA
YZV**

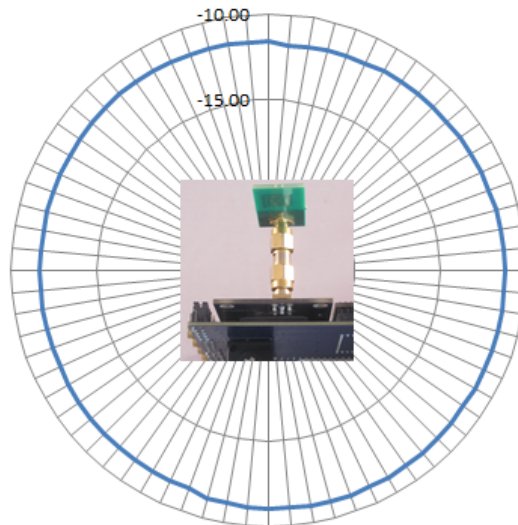


Figure 118. Radiation Pattern in the YZ Cut with Vertical Receiver Antenna Polarization

**Radiation Pattern in dBi, Small 434MHz ILA
YZH**

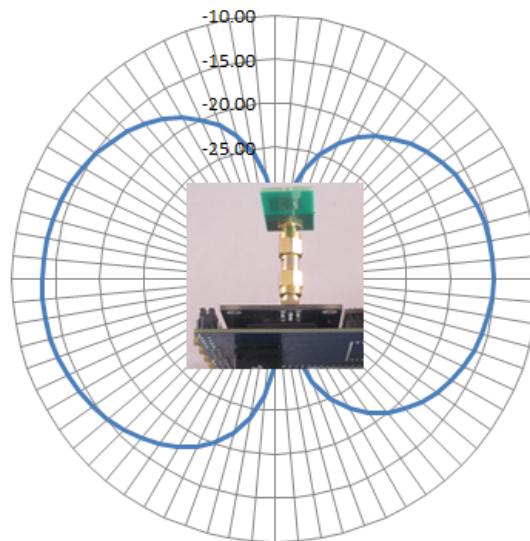


Figure 119. Radiation Pattern in the YZ Cut with Horizontal Receiver Antenna Polarization

9.4. Radiated Harmonics (WES0078-01-APL434S-01)

The radiated harmonics of the small sized printed ILA antenna were also measured in an antenna chamber using the 4455-PCE10D434 Pico Board connected through a male-to-male SMA transition with the WMB-930 Wireless Motherboard driving the Pico Board. The 4455-PCE10D434 Pico Board is set to a power state of 0x4F and a V_{DD} of ~2.9 V (two AA batteries) to deliver ~9 dBm, as Figure 112 shows. The maximum radiated power levels, up to the 10th harmonic, were measured in the XY, XZ, and YZ cut, with both horizontal and vertical polarized receiver antenna. The results are shown in the following EIRP table (Table 9) together with the corresponding standard limits.

The small sized ILA antenna driven by the Si4455/60 class E match complies with the ETSI harmonic regulations with margin.

Table 9. Radiated harmonics, Small ILA Antenna Board Driven by the Reduced Power (~+ 9 dBm) 4455-PCE10D434 and by the WMB-930 Wireless Motherboard

Cut.	Pol.	Freq.	f [MHz]	ETSI limit in EIRP [dBm]	Measured radiated power in EIRP [dBm]	Margin [dB]
XY	V	Fund.	434	12.14	-5.78	17.9
XY	V	2 nd	868	-33.88	-62.81	28.9
XY	V	3 rd	1302	-27.86	-66.60	38.7
XY	V	4 th	1736	-27.86	-55.39	27.5
XY	V	5 th	2170	-27.86	-40.87	13.0
XY	V	6 th	2604	-27.86	-42.90	15.0
XY	V	7 th	3038	-27.86	-46.35	18.5
XY	V	8 th	3472	-27.86	-47.03	19.2
XY	V	9 th	3906	-27.86	-47.58	19.7
XY	V	10 th	4340	-27.86	-41.72	13.9
XY	H	Fund.	434	12.14	-0.55	12.7
XY	H	2 nd	868	-33.88	-63.55	29.7
XY	H	3 rd	1302	-27.86	-69.60	41.7
XY	H	4 th	1736	-27.86	-52.89	25.0
XY	H	5 th	2170	-27.86	-46.53	18.7
XY	H	6 th	2604	-27.86	-42.17	14.3
XY	H	7 th	3038	-27.86	-46.46	18.6
XY	H	8 th	3472	-27.86	-49.21	21.3
XY	H	9 th	3906	-27.86	-48.28	20.4

Table 9. Radiated harmonics, Small ILA Antenna Board Driven by the Reduced Power (~+ 9 dBm) 4455-PCE10D434 and by the WMB-930 Wireless

Cut.	Pol.	Freq.	f [MHz]	ETSI limit in EIRP [dBm]	Measured radiated power in EIRP [dBm]	Margin [dB]
XY	H	10 th	4340	-27.86	-45.30	17.4
XZ	V	Fund.	434	12.14	-11.70	23.8
XZ	V	2 nd	868	-33.88	-61.69	27.8
XZ	V	3 rd	1302	-27.86	-67.28	39.4
XZ	V	4 th	1736	-27.86	-54.19	26.3
XZ	V	5 th	2170	-27.86	-42.10	14.2
XZ	V	6 th	2604	-27.86	-38.15	10.3
XZ	V	7 th	3038	-27.86	-43.81	15.9
XZ	V	8 th	3472	-27.86	-47.60	19.7
XZ	V	9 th	3906	-27.86	-47.58	19.7
XZ	V	10 th	4340	-27.86	-38.26	10.4
XZ	H	Fund.	434	12.14	0.54	11.6
XZ	H	2 nd	868	-33.88	-62.8	28.9
XZ	H	3 rd	1302	-27.86	-70.5	42.6
XZ	H	4 th	1736	-27.86	-47.7	19.9
XZ	H	5 th	2170	-27.86	-42.4	14.5
XZ	H	6 th	2604	-27.86	-37.2	9.4
XZ	H	7 th	3038	-27.86	-46	18.1
XZ	H	8 th	3472	-27.86	-46.6	18.7
XZ	H	9 th	3906	-27.86	-50.5	22.7
XZ	H	10 th	4340	-27.86	-42.3	14.4
YZ	V	Fund.	434	12.14	-1.98	14.1
YZ	V	2 nd	868	-33.88	-58.46	24.6
YZ	V	3 rd	1302	-27.86	-66.07	38.2

Table 9. Radiated harmonics, Small ILA Antenna Board Driven by the Reduced Power (~+ 9 dBm) 4455-PCE10D434 and by the WMB-930 Wireless

Cut.	Pol.	Freq.	f [MHz]	ETSI limit in EIRP [dBm]	Measured radiated power in EIRP [dBm]	Margin [dB]
YZ	V	4 th	1736	-27.86	-47.60	19.7
YZ	V	5 th	2170	-27.86	-45.27	17.4
YZ	V	6 th	2604	-27.86	-42.45	14.6
YZ	V	7 th	3038	-27.86	-45.15	17.3
YZ	V	8 th	3472	-27.86	-46.26	18.4
YZ	V	9 th	3906	-27.86	-51.16	23.3
YZ	V	10 th	4340	-27.86	-43.77	15.9
YZ	H	Fund.	434	12.14	-4.42	16.6
YZ	H	2 nd	868	-33.88	-66.12	32.2
YZ	H	3 rd	1302	-27.86	-69.46	41.6
YZ	H	4 th	1736	-27.86	-55.60	27.7
YZ	H	5 th	2170	-27.86	-46.03	18.2
YZ	H	6 th	2604	-27.86	-36.35	8.5
YZ	H	7 th	3038	-27.86	-47.28	19.4
YZ	H	8 th	3472	-27.86	-47.48	19.6
YZ	H	9 th	3906	-27.86	-50.05	22.2
YZ	H	10 th	4340	-27.86	-40.30	12.4

9.5. Range Test (WES0078-01-APL434S-01)

The available range was measured using the Range Test Demo. This application is supplied with the standard development kits for EZRadioPRO®. The target of this measurement is to find the distance between the transceivers where the unidirectional PER (Packet Error Rate, number of lost packets) is not more than 1% at each side with ten byte packet length. The GPS coordinates have been recorded for each spot. The distance between the spots has been measured using Google Maps, and results are shown in meters. The range tested between two identical units with the WMB-930 Wireless Motherboard, 4460-PCE10D434 Pico Board and the DUT (as shown in Figure 110) held by the users hand. During the tests the 4460-PCE10D434 Pico Board is set either to +10 dBm or a reduced (0 dBm) power state. The nominal +10 dBm power setting (state of 0x2D) valid at 3.3 V V_{DD} only. At 3 V V_{DD} , supplied by the two AA batteries, the power level is lower, around +8.8 dBm. At the nominal 0 dBm setting (state of 0x07) the power decrease is negligible at 3 V V_{DD} .

The range was tested in a flat land area without obstacles.

During the range test, the following settings have been used:

- Set 1: Txpow=10 dBm (~8.8 dBm @ 3 V V_{DD}), 40 kbps, 20 kHz dev., RXBW=82.64 kHz (sens ~-105.5 dBm)
- Set 2: Txpow=10 dBm (~8.8 dBm @ 3 V V_{DD}), 100 kbps, 50 kHz dev., RXBW=206.12 kHz (sens ~-100.7 dBm)
- Set 3: Txpow=0 dBm, 2.4 kbps, 2.4 kHz dev., RXBW=25.77 kHz (sens ~-115.9 dBm)

Using the above settings (Set 1, Set 2, and Set 3) the following range tests are done here:

1. Range measurement with the SMALL SIZE ILA Antenna Boards—The antenna boards are HORIZONTALLY polarized and the X-axes are facing each other (i.e., normal usage position). The applied setting is "Set 1".
2. Range measurement with the SMALL SIZE ILA Antenna Boards—The antenna boards are VERTICALLY polarized and the X-axes are facing each other (i.e., normal usage position). The applied setting is "Set 1".
3. Range measurement with the SMALL SIZE ILA Antenna Boards—The antenna boards are VERTICALLY polarized and the X-axes are facing each other (i.e., normal usage position). The applied setting is "Set 2".
4. Range measurement with the SMALL SIZE ILA Antenna Boards—The antenna boards are VERTICALLY polarized and the X-axes are facing each other (i.e., normal usage position). The applied setting is "Set 3".
5. Range measurement with the SMALL SIZE ILA Antenna Boards—The antenna boards are VERTICALLY polarized and the boards are facing each other in their direction of maximum radiation. The applied setting is "Set 1".
6. Reference range measurement with two 434 MHz REFERENCE MONOPOLE (ANT-433-HETH from Linx Technologies) in VERTICAL polarization using the setting denoted by "Set 1".
7. Reference range measurement with two 434 MHz REFERENCE MONOPOLE (ANT-433-HETH from Linx Technologies) in VERTICAL polarization using the setting denoted by "Set 3".
8. Reference range measurement with a 434 MHz REFERENCE MONOPOLE (ANT-433-HETH from Linx Technologies) in HORIZONTAL polarization using the setting denoted by "Set 1".

The measurement results are summarized in Figure 120.

Note: These range test results are valid with the above configuration and with moderate hand effect. In normal battery-operated, remote applications, where there is no large GND (motherboard) close to the antenna and where the antenna is usually very close to the user's hand, the achievable range is most likely shorter.

The indoor range test was not performed, due to the lack of a large enough building. But from the TX power and sensitivity data an indoor range estimation can be given, if one assumes a propagation factor of 4.5, which is a typical value in normal office environments. Use the Silicon Labs' range calculator, which can be found here:

<http://www.silabs.com/support/pages/document-library.aspx?p=Wireless&f=EZRadioPRO&pn=Si4460>

Assuming -14.8 dBi antenna gain (front direction, X-axis facing) and the setting "Set 1" (40 kbps, 1% PER, +8.8 dBm), the estimated indoor range is 32 m, as shown in Figure 121. To the maximum antenna gain direction, the indoor range between two identical units is ~60 m.

		Set1	10dBm	40kbps	+/-20kHz	GPS		Distance [m]	
		Set2	10dBm	100kbps	+/-50kHz	N	E		
F	Small Printed ILA				Base	47.152880°	19.180930°	0.0	
Small Printed ILA (WES0078)	H pol; Norm. direction					GPS		342.6	
	1	Set1	10dBm	40kbps	+/-20kHz	47.154820°	19.177410°		
	V pol; Norm. direction					GPS		384.5 285.7 356.7	
	2	Set1	10dBm	40kbps	+/-20kHz	47.155090°	19.177020°		
	3	Set2	10dBm	100kbps	+/-50kHz	47.154460°	19.177950°		
	4	Set3	0dBm	2.4kbps	+/-2.4kHz	47.154920°	19.177290°		
	Max. direction: XZH 230°					GPS		649.8	
	5	Set1	10dBm	40kbps	+/-20kHz	47.156840°	19.174610°		
	ANT-433-HEATH from LINX	V pol; Norm. direction					GPS		1778.7 1188.2
		6	Set1	10dBm	40kbps	+/-20kHz	47.167850°	19.172640°	
7		Set3	0dBm	2.4kbps	+/-2.4kHz	47.162300°	19.17351°		
H pol; Norm. direction					GPS		1315.3		
8		Set1	10dBm	40kbps	+/-20kHz	47.163520°		19.173330°	

Figure 120. Outdoor Range Test Results with Two Identical Small Sized Printed ILA Antenna Boards Driven by Reduced Power 4460-PCE10D434 Pico Boards and WMB-930 Wireless Motherboards. Range Test Results with Reference Monopoles are Also Shown.

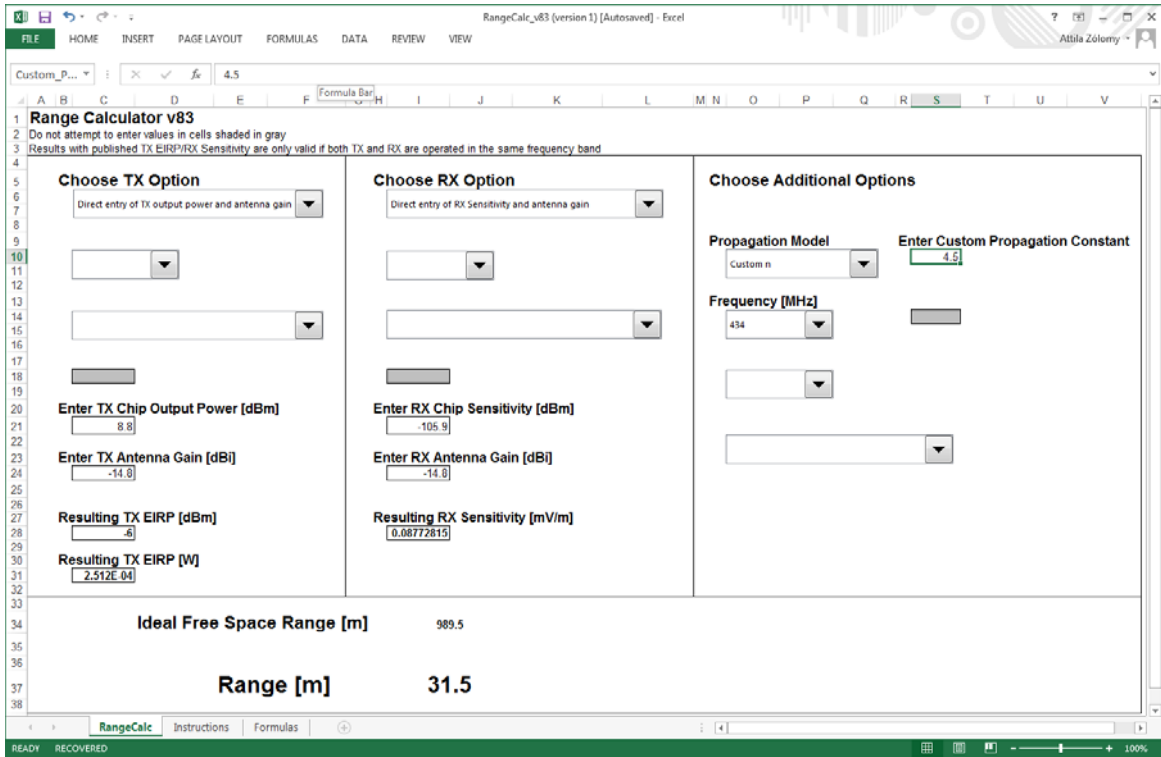
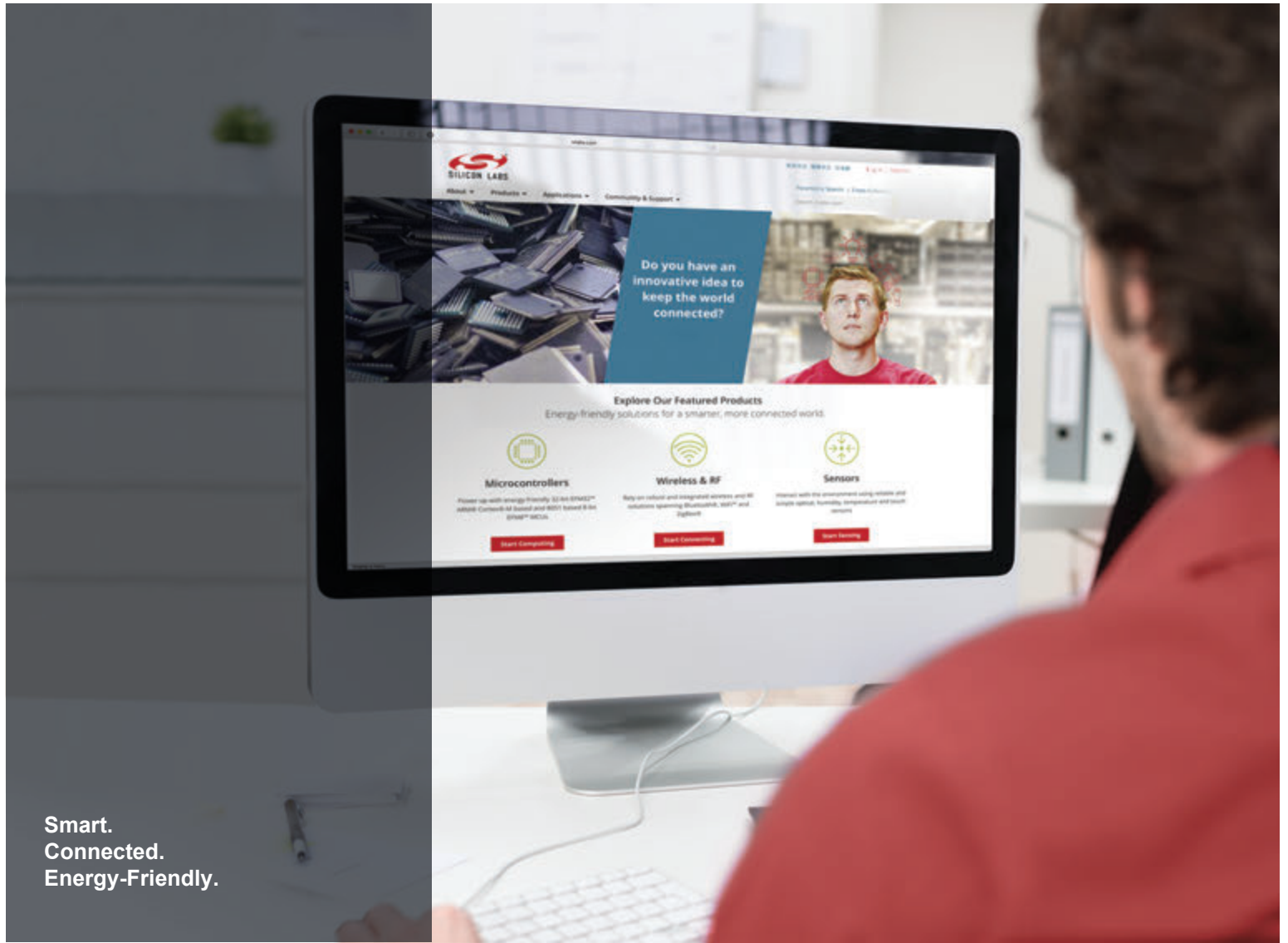


Figure 121. Indoor Range Estimation with Two Identical Small Sized Printed ILA Antenna Boards Driven by Reduced Power 4460-PCE10D434 Pico Boards and WMB-930 Wireless Motherboards



Smart.
Connected.
Energy-Friendly.



Products
www.silabs.com/products



Quality
www.silabs.com/quality



Support and Community
community.silabs.com

Disclaimer

Silicon Laboratories intends to provide customers with the latest, accurate, and in-depth documentation of all peripherals and modules available for system and software implementers using or intending to use the Silicon Laboratories products. Characterization data, available modules and peripherals, memory sizes and memory addresses refer to each specific device, and "Typical" parameters provided can and do vary in different applications. Application examples described herein are for illustrative purposes only. Silicon Laboratories reserves the right to make changes without further notice and limitation to product information, specifications, and descriptions herein, and does not give warranties as to the accuracy or completeness of the included information. Silicon Laboratories shall have no liability for the consequences of use of the information supplied herein. This document does not imply or express copyright licenses granted hereunder to design or fabricate any integrated circuits. The products are not designed or authorized to be used within any Life Support System without the specific written consent of Silicon Laboratories. A "Life Support System" is any product or system intended to support or sustain life and/or health, which, if it fails, can be reasonably expected to result in significant personal injury or death. Silicon Laboratories products are not designed or authorized for military applications. Silicon Laboratories products shall under no circumstances be used in weapons of mass destruction including (but not limited to) nuclear, biological or chemical weapons, or missiles capable of delivering such weapons.

Trademark Information

Silicon Laboratories Inc.®, Silicon Laboratories®, Silicon Labs®, SiLabs® and the Silicon Labs logo®, Bluegiga®, Bluegiga Logo®, Clockbuilder®, CMEMS®, DSPLL®, EFM®, EFM32®, EFR®, Ember®, Energy Micro, Energy Micro logo and combinations thereof, "the world's most energy friendly microcontrollers", Ember®, EZLink®, EZRadio®, EZRadioPRO®, Gecko®, ISOModem®, Precision32®, ProSLIC®, Simplicity Studio®, SiPHY®, Telegesis, the Telegesis Logo®, USBXpress® and others are trademarks or registered trademarks of Silicon Laboratories Inc. ARM, CORTEX, Cortex-M3 and THUMB are trademarks or registered trademarks of ARM Holdings. Keil is a registered trademark of ARM Limited. All other products or brand names mentioned herein are trademarks of their respective holders.



Silicon Laboratories Inc.
400 West Cesar Chavez
Austin, TX 78701
USA

<http://www.silabs.com>