

# Si8660/61/62/63 データ・シート

## 低電力 6 チャンネル・デジタル・アイソレータ

Silicon Lab の超低電力デジタル・アイソレータ・ファミリは、従来の絶縁技術に比べて非常に優れたデータ・レート、伝搬遅延、性能、サイズ、信頼性、外部部品表 (BOM) を提供する CMOS デバイスです。これらの製品の動作パラメータは、広範な温度範囲にわたって安定しており、デバイスの耐用年数を通じて、設計作業の簡素化と均一性の均質な性能を実現します。すべてのデバイス・バージョンにシュミット・トリガ入力搭載されているため、ノイズ耐性が高く、VDD バイパス・コンデンサしか必要としません。

最大 150 Mbps のデータ・レートがサポートされており、すべてのデバイスで 10 ns 未満の伝搬遅延を実現します。注文オプションでは、絶縁定格 (1.0、2.5、3.75、5 kV) と、電力損失時のデフォルトの出力状態を制御するフェイル・セーフ動作モードを選択することができます。>1 kV<sub>RMS</sub> のすべての製品が UL、CSA、VDE、CQC による安全性の認証を受けており、ワイドボディ・パッケージの製品は最大 5 kV<sub>RMS</sub> に耐える強化絶縁をサポートしています。

### アプリケーション

- ・ 工業オートメーション・システム
- ・ 医療用電子機器
- ・ ハイブリッド電気自動車
- ・ 絶縁スイッチ・モード電源
- ・ 絶縁 ADC、DAC
- ・ モータ制御
- ・ 電力インバータ
- ・ 通信システム

### 安全規制の承認

- ・ UL 1577 認定済み
  - ・ 1 分間で最大 5000 V<sub>RMS</sub>
- ・ CSA 部品通知 5A 承認
  - ・ IEC 60950-1、62368-1、60601-1 (強化絶縁)
- ・ VDE 適合性認証
  - ・ VDE 0884-10
  - ・ EN60950-1 (強化絶縁)
- ・ CQC 認証の承認
  - ・ GB4943.1

### 主な機能

- ・ 高速動作
  - ・ DC ~ 150 Mbps
- ・ スタートアップ・イニシャライゼーション不要
- ・ 幅広い動作供給電圧
  - ・ 2.5 ~ 5.5 V
- ・ 最大 5000 V<sub>RMS</sub> の絶縁
- ・ 定格使用電圧で 60 年の耐用年数
- ・ 高い電磁耐久性
- ・ 超低電力 (代表値)
  - ・ 5 V 動作
    - ・ 1 Mbps において各チャンネルにつき 1.6 mA
    - ・ 100 Mbps において各チャンネルにつき 5.5 mA
  - ・ 2.5 V 動作
    - ・ 1 Mbps において各チャンネルにつき 1.5 mA
    - ・ 100 Mbps において各チャンネルにつき 3.5 mA
- ・ シュミット・トリガ入力
- ・ 選択可能なフェイル・セーフ・モード
  - ・ デフォルトの高出力または低出力 (注文オプション)
- ・ 正確なタイミング (代表値)
  - ・ 10 ns の伝搬遅延
  - ・ 1.5 ns のパルス幅ひずみ
  - ・ 0.5 ns チャンネル対チャンネルのスキュー
  - ・ 2 ns の伝搬遅延スキュー
  - ・ 5 ns の最小パルス幅
- ・ 50 kV/μs のトランジェント耐久性
- ・ AEC-Q100 認定
- ・ 幅広い温度範囲
  - ・ -40 ~ 125 °C
- ・ RoHS 準拠パッケージ
  - ・ SOIC-16 ワイド・ボディ
  - ・ SOIC-16 ナロー・ボディ
  - ・ QSOP-16

## 1. Ordering Guide

Table 1.1. Ordering Guide for Valid OPNs 1,2,3

Ordering Part Number (OPN)	Number of Inputs VDD1 Side	Number of Inputs VDD2 Side	Max Data Rate (Mbps)	Default Output State	Isolation Rating (kV)	Temp (°C)	Package
<b>QSOP-16 Packages</b>							
Si8660BB-B-IU	6	0	150	Low	2.5	–40 to 125 °C	QSOP-16
Si8660EB-B-IU	6	0	150	High	2.5	–40 to 125 °C	QSOP-16
Si8661BB-B-IU	5	1	150	Low	2.5	–40 to 125 °C	QSOP-16
Si8661EB-B-IU	5	1	150	High	2.5	–40 to 125 °C	QSOP-16
Si8662BB-B-IU	4	2	150	Low	2.5	–40 to 125 °C	QSOP-16
Si8662EB-B-IU	4	2	150	High	2.5	–40 to 125 °C	QSOP-16
Si8663BB-B-IU	3	3	150	Low	2.5	–40 to 125 °C	QSOP-16
Si8663EB-B-IU	3	3	150	High	2.5	–40 to 125 °C	QSOP-16
<b>SOIC-16 Packages</b>							
Si8660BA-B-IS1	6	0	150	Low	1.0	–40 to 125 °C	NB SOIC-16
Si8660BB-B-IS1	6	0	150	Low	2.5	–40 to 125 °C	NB SOIC-16
Si8660BC-B-IS1	6	0	150	Low	3.75	–40 to 125 °C	NB SOIC-16
Si8660EC-B-IS1	6	0	150	High	3.75	–40 to 125 °C	NB SOIC-16
Si8660BD-B-IS	6	0	150	Low	5.0	–40 to 125 °C	WB SOIC-16
Si8660ED-B-IS	6	0	150	High	5.0	–40 to 125 °C	WB SOIC-16
Si8661BB-B-IS1	5	1	150	Low	2.5	–40 to 125 °C	NB SOIC-16
Si8661BC-B-IS1	5	1	150	Low	3.75	–40 to 125 °C	NB SOIC-16
Si8661EC-B-IS1	5	1	150	High	3.75	–40 to 125 °C	NB SOIC-16
Si8661BD-B-IS	5	1	150	Low	5.0	–40 to 125 °C	WB SOIC-16
Si8661ED-B-IS	5	1	150	High	5.0	–40 to 125 °C	WB SOIC-16
Si8661BD-B-IS2	5	1	150	Low	5.0	–40 to 125 °C	WB SOIC-16 (8 mm cree-page) <sup>4</sup>
Si8662BB-B-IS1	4	2	150	Low	2.5	–40 to 125 °C	NB SOIC-16
Si8662BC-B-IS1	4	2	150	Low	3.75	–40 to 125 °C	NB SOIC-16
Si8662EC-B-IS1	4	2	150	High	3.75	–40 to 125 °C	NB SOIC-16
Si8662BD-B-IS	4	2	150	Low	5.0	–40 to 125 °C	WB SOIC-16
Si8662ED-B-IS	4	2	150	High	5.0	–40 to 125 °C	WB SOIC-16
Si8663BB-B-IS1	3	3	150	Low	2.5	–40 to 125 °C	NB SOIC-16
Si8663BC-B-IS1	3	3	150	Low	3.75	–40 to 125 °C	NB SOIC-16
Si8663EC-B-IS1	3	3	150	High	3.75	–40 to 125 °C	NB SOIC-16
Si8663BD-B-IS	3	3	150	Low	5.0	–40 to 125 °C	WB SOIC-16

Ordering Part Number (OPN)	Number of Inputs VDD1 Side	Number of Inputs VDD2 Side	Max Data Rate (Mbps)	Default Output State	Isolation Rating (kV)	Temp (°C)	Package
Si8663ED-B-IS	3	3	150	High	5.0	–40 to 125 °C	WB SOIC-16

**Notes:**

1. All packages are RoHS-compliant with peak reflow temperatures of 260 °C according to the JEDEC industry standard classifications and peak solder temperatures.
2. "Si" and "SI" are used interchangeably.
3. An "R" at the end of the part number denotes tape and reel packaging option.
4. The package designated IS2 has a design that eliminates tie bars, thus allowing for extra creepage distance while maintaining standard WB SOIC-16 package dimensions and land pattern.

# Table of Contents

<b>1. Ordering Guide</b>	<b>2</b>
<b>2. Functional Description</b>	<b>5</b>
2.1 Theory of Operation	5
2.2 Eye Diagram	6
<b>3. Device Operation</b>	<b>7</b>
3.1 Device Startup	7
3.2 Undervoltage Lockout	8
3.3 Layout Recommendations	8
3.3.1 Supply Bypass	8
3.3.2 Output Pin Termination	8
3.4 Fail-Safe Operating Mode	8
3.5 Typical Performance Characteristics	9
<b>4. Electrical Specifications</b>	<b>11</b>
<b>5. Pin Descriptions</b>	<b>27</b>
<b>6. Package Outline (16-Pin Wide Body SOIC)</b>	<b>28</b>
<b>7. Land Pattern (16-Pin Wide-Body SOIC)</b>	<b>30</b>
<b>8. Package Outline (16-Pin Narrow Body SOIC)</b>	<b>31</b>
<b>9. Land Pattern (16-Pin Narrow Body SOIC)</b>	<b>33</b>
<b>10. Package Outline (16-Pin QSOP)</b>	<b>34</b>
<b>11. Land Pattern (16-Pin QSOP)</b>	<b>36</b>
<b>12. Top Marking (16-Pin Wide Body SOIC)</b>	<b>37</b>
<b>13. Top Marking (16-Pin Narrow Body SOIC)</b>	<b>38</b>
<b>14. Top Marking (16-Pin QSOP)</b>	<b>39</b>
<b>15. Document Change List</b>	<b>40</b>

## 2. Functional Description

### 2.1 Theory of Operation

The operation of an Si866x channel is analogous to that of an opto coupler, except an RF carrier is modulated instead of light. This simple architecture provides a robust isolated data path and requires no special considerations or initialization at start-up. A simplified block diagram for a single Si866x channel is shown in the figure below.

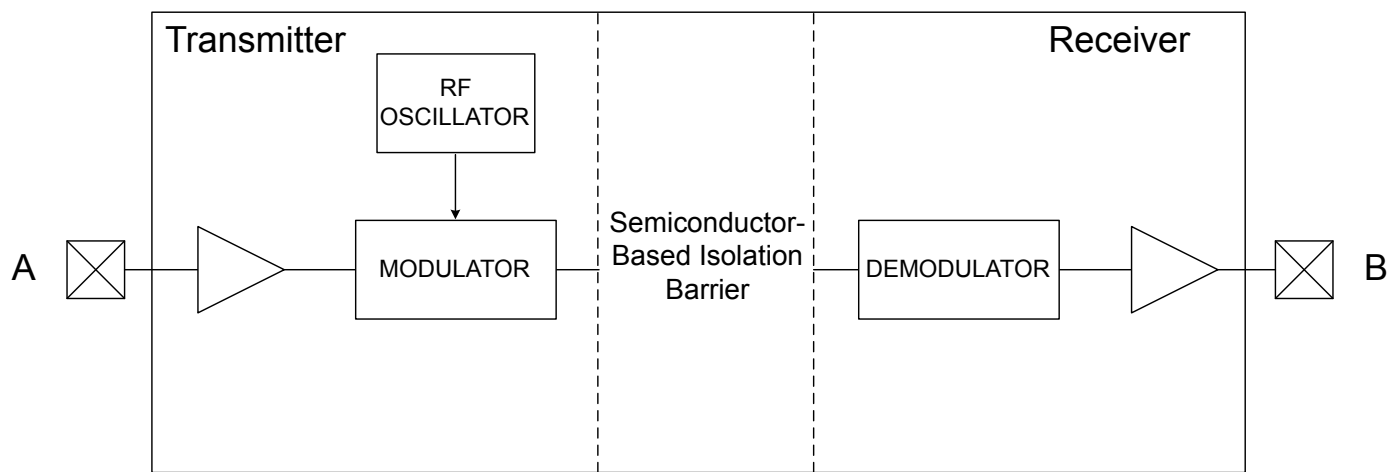

Figure 2.1. Simplified Channel Diagram

A channel consists of an RF Transmitter and RF Receiver separated by a semiconductor-based isolation barrier. Referring to the Transmitter, input A modulates the carrier provided by an RF oscillator using on/off keying. The Receiver contains a demodulator that decodes the input state according to its RF energy content and applies the result to output B via the output driver. This RF on/off keying scheme is superior to pulse code schemes as it provides best-in-class noise immunity, low power consumption, and better immunity to magnetic fields. See the figure below for more details.

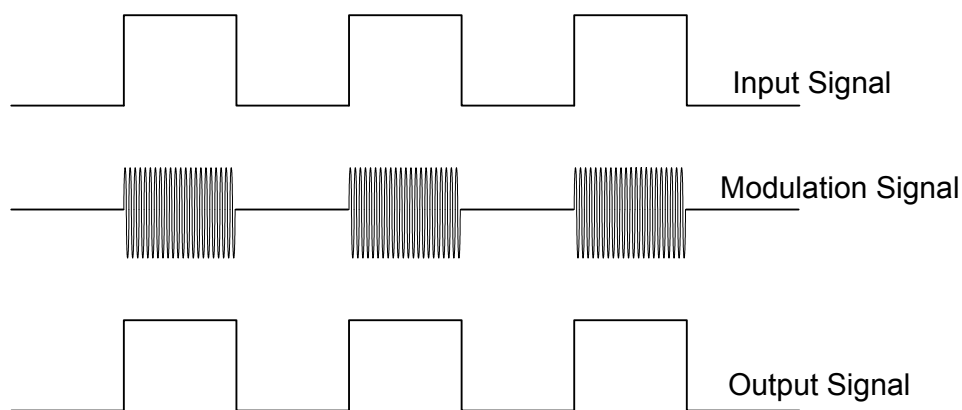

Figure 2.2. Modulation Scheme

## 2.2 Eye Diagram

The figure below illustrates an eye-diagram taken on an Si8660. For the data source, the test used an Anritsu (MP1763C) Pulse Pattern Generator set to 1000 ns/div. The output of the generator's clock and data from an Si8660 were captured on an oscilloscope. The results illustrate that data integrity was maintained even at the high data rate of 150 Mbps. The results also show that 2 ns pulse width distortion and 350 ps peak jitter were exhibited.

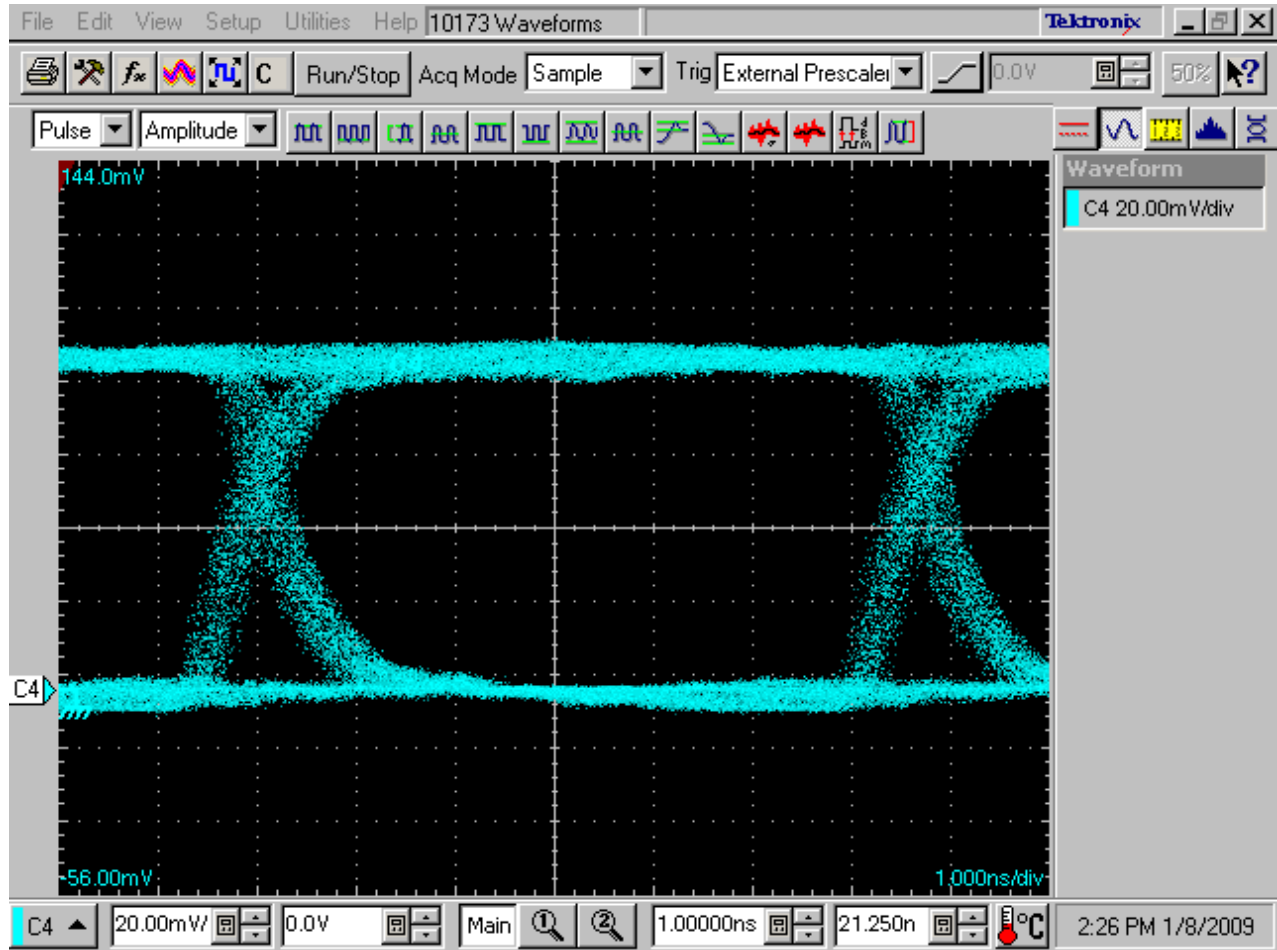

Figure 2.3. Eye Diagram

### 3. Device Operation

Device behavior during start-up, normal operation, and shutdown is shown in [Figure 3.1 Device Behavior during Normal Operation on page 8](#), where UVLO+ and UVLO- are the positive-going and negative-going thresholds respectively. Refer to the table below to determine outputs when power supply (VDD) is not present.

**Table 3.1. Si866x Logic Operation**

V <sub>I</sub> Input <sup>1,2</sup>	VDDI State <sup>1,3,4</sup>	VDDO State <sup>1,3,4</sup>	V <sub>O</sub> Output <sup>1,2</sup>	Comments
H	P	P	H	Normal operation.
L	P	P	L	
X <sup>5</sup>	UP	P	L <sup>6</sup> H <sup>6</sup>	Upon transition of VDDI from unpowered to powered, V <sub>O</sub> returns to the same state as V <sub>I</sub> in less than 1 μs.
X <sup>5</sup>	P	UP	Undetermined	Upon transition of VDDO from unpowered to powered, V <sub>O</sub> returns to the same state as V <sub>I</sub> within 1 μs.

**Notes:**

- VDDI and VDDO are the input and output power supplies. V<sub>I</sub> and V<sub>O</sub> are the respective input and output terminals.
- X = not applicable; H = Logic High; L = Logic Low; Hi-Z = High Impedance.
- “Powered” state (P) is defined as 2.5 V < VDD < 5.5 V.
- “Unpowered” state (UP) is defined as VDD = 0 V.
- Note that an I/O can power the die for a given side through an internal diode if its source has adequate current.
- See [1. Ordering Guide](#) for details. This is the selectable fail-safe operating mode (ordering option). Some devices have default output state = H, and some have default output state = L, depending on the ordering part number (OPN). For default high devices, the data channels have pull-ups on inputs/outputs. For default low devices, the data channels have pull-downs on inputs/outputs.

#### 3.1 Device Startup

Outputs are held low during powerup until VDD is above the UVLO threshold for time period tSTART. Following this, the outputs follow the states of inputs.

### 3.2 Undervoltage Lockout

Undervoltage Lockout (UVLO) is provided to prevent erroneous operation during device startup and shutdown or when VDD is below its specified operating circuits range. Both Side A and Side B each have their own undervoltage lockout monitors. Each side can enter or exit UVLO independently. For example, Side A unconditionally enters UVLO when  $V_{DD1}$  falls below  $V_{DD1(UVLO-)}$  and exits UVLO when  $V_{DD1}$  rises above  $V_{DD1(UVLO+)}$ . Side B operates the same as Side A with respect to its  $V_{DD2}$  supply.

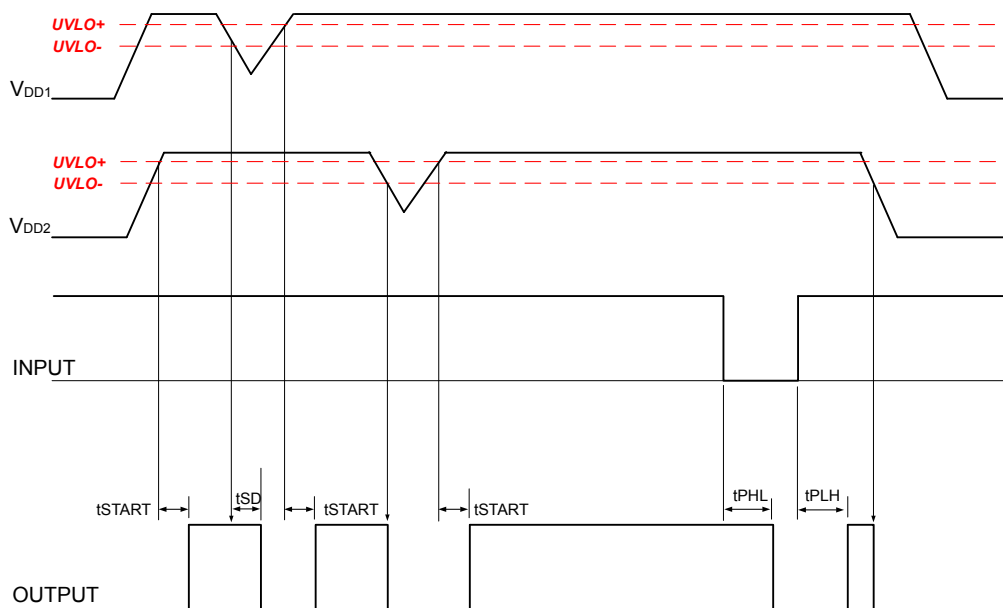

Figure 3.1. Device Behavior during Normal Operation

### 3.3 Layout Recommendations

To ensure safety in the end user application, high voltage circuits (i.e., circuits with  $>30 V_{AC}$ ) must be physically separated from the safety extra-low voltage circuits (SELV is a circuit with  $<30 V_{AC}$ ) by a certain distance (creepage/clearance). If a component, such as a digital isolator, straddles this isolation barrier, it must meet those creepage/clearance requirements and also provide a sufficiently large high-voltage breakdown protection rating (commonly referred to as working voltage protection). [Table 4.5 Regulatory Information<sup>1</sup> on page 22](#) and [4. Electrical Specifications](#) detail the working voltage and creepage/clearance capabilities of the Si86xx. These tables also detail the component standards (UL1577, IEC60747, CSA 5A), which are readily accepted by certification bodies to provide proof for end-system specifications requirements. Refer to the end-system specification (61010-1, 60950-1, 60601-1, etc.) requirements before starting any design that uses a digital isolator.

#### 3.3.1 Supply Bypass

The Si866x family requires a  $0.1 \mu F$  bypass capacitor between  $V_{DD1}$  and GND1 and  $V_{DD2}$  and GND2. The capacitor should be placed as close as possible to the package. To enhance the robustness of a design, the user may also include resistors ( $50\text{--}300 \Omega$ ) in series with the inputs and outputs if the system is excessively noisy.

#### 3.3.2 Output Pin Termination

The nominal output impedance of an isolator driver channel is approximately  $50 \Omega$ ,  $\pm 40\%$ , which is a combination of the value of the on-chip series termination resistor and channel resistance of the output driver FET. When driving loads where transmission line effects will be a factor, output pins should be appropriately terminated with controlled impedance PCB traces.

### 3.4 Fail-Safe Operating Mode

Si86xx devices feature a selectable (by ordering option) mode whereby the default output state (when the input supply is unpowered) can either be a logic high or logic low when the output supply is powered. See [Table 3.1 Si866x Logic Operation on page 7](#) and [1. Ordering Guide](#) for more information.



### 3.5 Typical Performance Characteristics

The typical performance characteristics depicted in the following diagrams are for information purposes only. Refer to the electrical characteristics tables for actual specification limits.

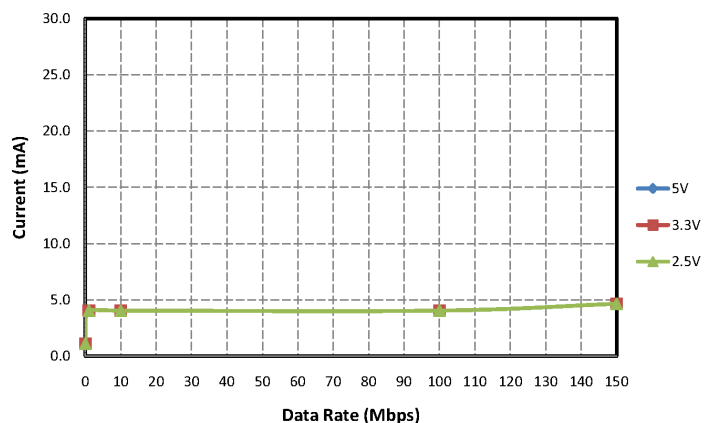

Figure 3.2. Si8660 Typical  $V_{DD1}$  Supply Current vs. Data Rate 5, 3.3, and 2.5 V Operation

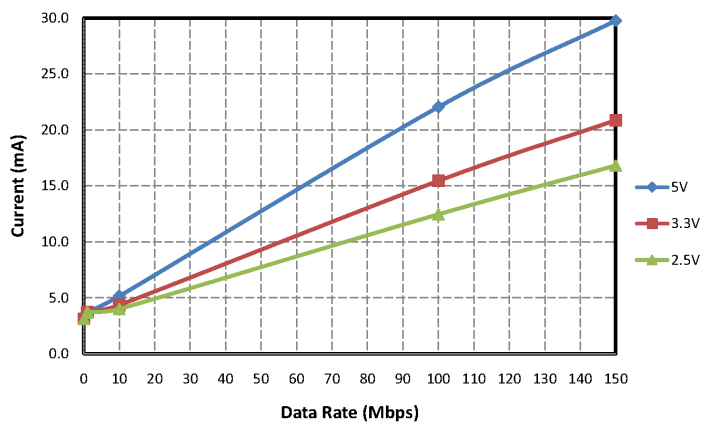

Figure 3.3. Si8661 Typical  $V_{DD1}$  Supply Current vs. Data Rate 5, 3.3, and 2.5 V Operation (15 pF Load)

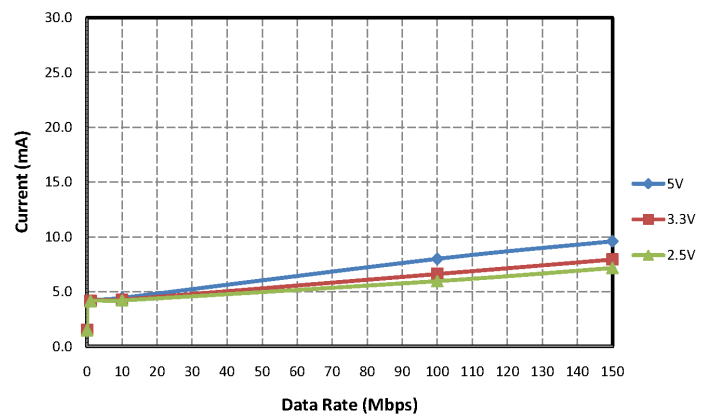

Figure 3.4. Si8662 Typical  $V_{DD1}$  Supply Current vs. Data Rate 5, 3.3, and 2.5 V Operation (15 pF Load)

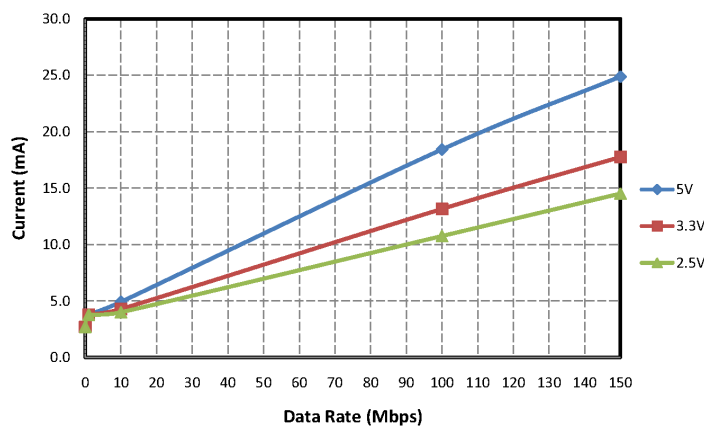

Figure 3.5. Si8660 Typical  $V_{DD2}$  Supply Current vs. Data Rate 5, 3.3, and 2.5 V Operation (15 pF Load)

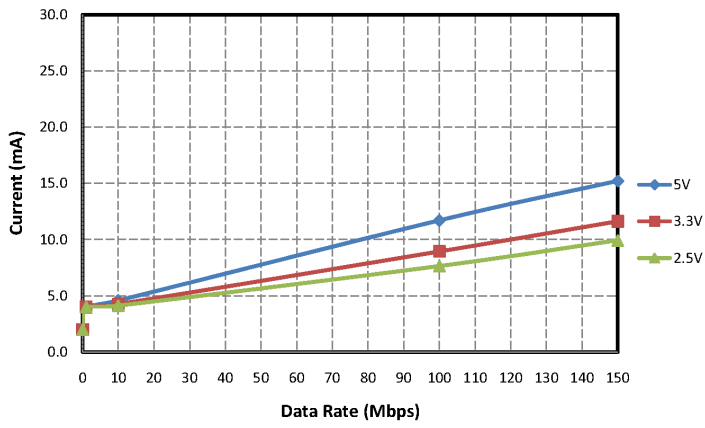

Figure 3.6. Si8661 Typical  $V_{DD2}$  Supply Current vs. Data Rate 5, 3.3, and 2.5 V Operation (15 pF Load)

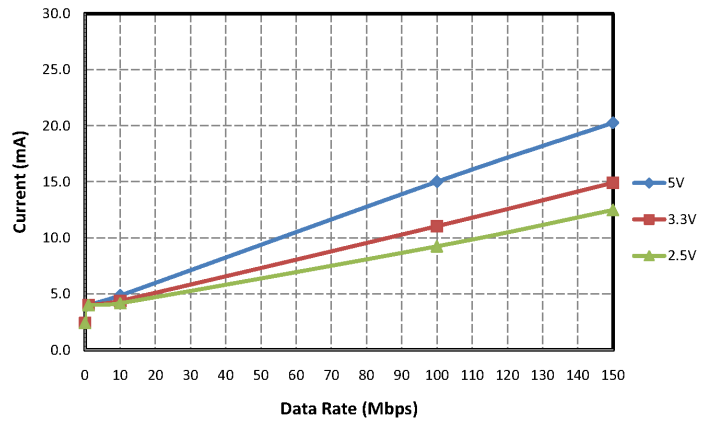

Figure 3.7. Si8662 Typical  $V_{DD2}$  Supply Current vs. Data Rate 5, 3.3, and 2.5 V Operation (15 pF Load)

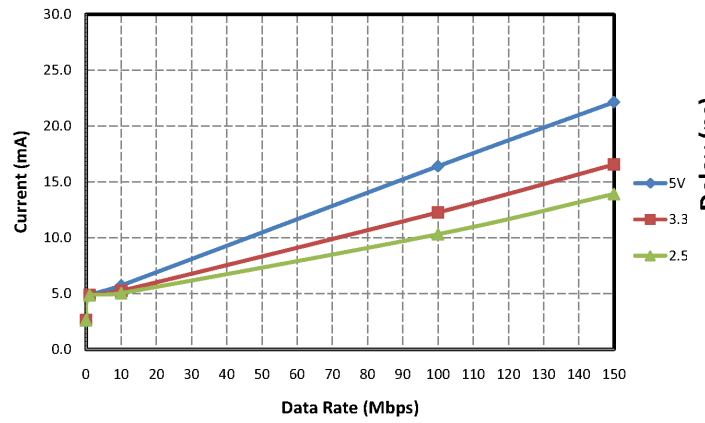

Figure 3.8. Si8663 Typical  $V_{DD1}$  or  $V_{DD2}$  Supply Current vs. Data Rate 5, 3.3, and 2.5 V Operation (15 pF Load)

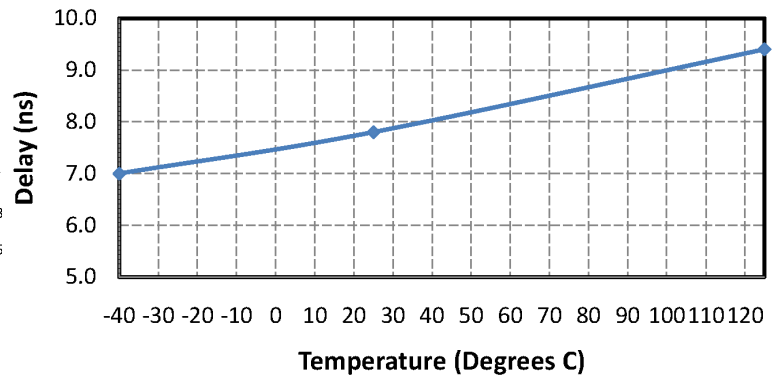

Figure 3.9. Propagation Delay vs. Temperature

## 4. Electrical Specifications

**Table 4.1. Recommended Operating Conditions**

Parameter	Symbol	Min	Typ	Max	Unit
Junction Operating Temperature	$T_J$	—	—	150	$^{\circ}\text{C}$
Ambient Operating Temperature <sup>1</sup>	$T_A$	-40	25	125	$^{\circ}\text{C}$
Supply Voltage	$V_{DD1}$	2.375	—	5.5	V
	$V_{DD2}$	2.375	—	5.5	V

**Note:**

1. The maximum ambient temperature is dependent on data frequency, output loading, number of operating channels, and supply voltage.

**Table 4.2. Electrical Characteristics**

( $V_{DD1} = 5\text{ V} \pm 10\%$ ,  $V_{DD2} = 5\text{ V} \pm 10\%$ ,  $T_A = -40$  to  $125\text{ }^{\circ}\text{C}$ )

Parameter	Symbol	Test Condition	Min	Typ	Max	Unit
VDD Undervoltage Threshold	VDDUV+	$V_{DD1}, V_{DD2}$ rising	1.95	2.24	2.375	V
VDD Undervoltage Threshold	VDDUV-	$V_{DD1}, V_{DD2}$ falling	1.88	2.16	2.325	V
VDD Undervoltage Hysteresis	$V_{DDHYS}$		50	70	95	mV
Positive-Going Input Threshold	$V_{T+}$	All inputs rising	1.4	1.67	1.9	V
Negative-Going Input Threshold	$V_{T-}$	All inputs falling	1.0	1.23	1.4	V
Input Hysteresis	$V_{HYS}$		0.38	0.44	0.50	V
High Level Input Voltage	$V_{IH}$		2.0	—	—	V
Low Level Input Voltage	$V_{IL}$		—	—	0.8	V
High Level Output Voltage	$V_{OH}$	$I_{OH} = -4\text{ mA}$	$V_{DD1}, V_{DD2} - 0.4$	4.8	—	V
Low Level Output Voltage	$V_{OL}$	$I_{OL} = 4\text{ mA}$	—	0.2	0.4	V
Input Leakage Current	$I_L$		—	—	$\pm 10$	$\mu\text{A}$
Output Impedance <sup>1</sup>	$Z_O$		—	50	—	$\Omega$

**DC Supply Current (All Inputs 0 V or at Supply)**

<b>Si8660Bx, Ex</b>						
$V_{DD1}$		$V_I = 0(\text{Bx}), 1(\text{Ex})$	—	1.2	1.9	mA
$V_{DD2}$		$V_I = 0(\text{Bx}), 1(\text{Ex})$	—	3.5	5.3	
$V_{DD1}$		$V_I = 1(\text{Bx}), 0(\text{Ex})$	—	8.8	12.3	
$V_{DD2}$		$V_I = 1(\text{Bx}), 0(\text{Ex})$	—	3.7	5.6	

Parameter	Symbol	Test Condition	Min	Typ	Max	Unit
<b>Si8661Bx, Ex</b>						
$V_{DD1}$		$V_I = 0(\text{Bx}), 1(\text{Ex})$	—	1.7	2.7	mA
$V_{DD2}$		$V_I = 0(\text{Bx}), 1(\text{Ex})$	—	3.4	5.1	
$V_{DD1}$		$V_I = 1(\text{Bx}), 0(\text{Ex})$	—	7.9	11.1	
$V_{DD2}$		$V_I = 1(\text{Bx}), 0(\text{Ex})$	—	4.8	7.2	
<b>Si8662Bx, Ex</b>						
$V_{DD1}$		$V_I = 0(\text{Bx}), 1(\text{Ex})$	—	2.2	3.3	mA
$V_{DD2}$		$V_I = 0(\text{Bx}), 1(\text{Ex})$	—	3.0	4.5	
$V_{DD1}$		$V_I = 1(\text{Bx}), 0(\text{Ex})$	—	7.5	10.5	
$V_{DD2}$		$V_I = 1(\text{Bx}), 0(\text{Ex})$	—	5.6	8.4	
<b>Si8663Bx, Ex</b>						
$V_{DD1}$		$V_I = 0(\text{Bx}), 1(\text{Ex})$	—	2.6	3.9	mA
$V_{DD2}$		$V_I = 0(\text{Bx}), 1(\text{Ex})$	—	2.6	3.9	
$V_{DD1}$		$V_I = 1(\text{Bx}), 0(\text{Ex})$	—	6.5	9.1	
$V_{DD2}$		$V_I = 1(\text{Bx}), 0(\text{Ex})$	—	6.5	9.1	
<b>1 Mbps Supply Current (All Inputs = 500 kHz Square Wave, CI = 15 pF on all Outputs)</b>						
<b>Si8660Bx, Ex</b>						
$V_{DD1}$			—	5.0	7.0	mA
$V_{DD2}$			—	4.2	5.9	
<b>Si8661Bx, Ex</b>						
$V_{DD1}$			—	4.9	6.9	mA
$V_{DD2}$			—	4.6	6.4	
<b>Si8662Bx, Ex</b>						
$V_{DD1}$			—	5.1	7.1	mA
$V_{DD2}$			—	4.7	6.6	
<b>Si8663Bx, Ex</b>						
$V_{DD1}$			—	4.9	6.8	mA
$V_{DD2}$			—	4.9	6.8	
<b>10 Mbps Supply Current (All Inputs = 5 MHz Square Wave, CI = 15 pF on all Outputs)</b>						
<b>Si8660Bx, Ex</b>						
$V_{DD1}$			—	5.0	7.0	mA
$V_{DD2}$			—	5.9	8.3	
<b>Si8661Bx, Ex</b>						
$V_{DD1}$			—	5.2	7.3	mA
$V_{DD2}$			—	6.1	8.5	

Parameter	Symbol	Test Condition	Min	Typ	Max	Unit
<b>Si8662Bx, Ex</b>						
$V_{DD1}$			—	5.6	7.9	mA
$V_{DD2}$			—	5.9	8.2	
<b>Si8663Bx, Ex</b>						
$V_{DD1}$			—	5.7	8.0	mA
$V_{DD2}$			—	5.7	8.0	
<b>100 Mbps Supply Current (All Inputs = 50 MHz Square Wave, CI = 15 pF on All Outputs)</b>						
<b>Si8660Bx, Ex</b>						
$V_{DD1}$			—	5.0	7.0	mA
$V_{DD2}$			—	26.2	34.1	
<b>Si8661Bx, Ex</b>						
$V_{DD1}$			—	8.8	11.8	mA
$V_{DD2}$			—	23	29.8	
<b>Si8662Bx, Ex</b>						
$V_{DD1}$			—	12.8	16.6	mA
$V_{DD2}$			—	19.4	25.2	
<b>Si8663Bx, Ex</b>						
$V_{DD1}$			—	16.4	21.3	mA
$V_{DD2}$			—	16.4	21.3	
<b>Timing Characteristics</b>						
<b>Si866xBx, Ex</b>						
Maximum Data Rate			0	—	150	Mbps
Minimum Pulse Width			—	—	5.0	ns
Propagation Delay	$t_{PHL}, t_{PLH}$	See <a href="#">Figure 4.1 Propagation Delay Timing on page 14</a>	5.0	8.0	13	ns
Pulse Width Distortion $ t_{PLH} - t_{PHL} $	PWD	See <a href="#">Figure 4.1 Propagation Delay Timing on page 14</a>	—	0.2	4.5	ns
Propagation Delay Skew <sup>2</sup>	$t_{PSK(P-P)}$		—	2.0	4.5	ns
Channel-Channel Skew	$t_{PSK}$		—	0.4	2.5	ns
<b>All Models</b>						
Output Rise Time	$t_r$	$C_L = 15$ pF (See <a href="#">Figure 4.1 Propagation Delay Timing on page 14</a> )	—	2.5	4.0	ns
Output Fall Time	$t_f$	$C_L = 15$ pF (See <a href="#">Figure 4.1 Propagation Delay Timing on page 14</a> )	—	2.5	4.0	ns
Peak Eye Diagram Jitter	$t_{JIT(PK)}$	See	—	350	—	ps

Parameter	Symbol	Test Condition	Min	Typ	Max	Unit
Common Mode Transient Immunity	CMTI	$V_I = V_{DD}$ or 0 V $V_{CM} = 1500$ V (See Figure 4.2 Common Mode Transient Immunity Test Circuit on page 15)	35	50	—	kV/ $\mu$ s
Startup Time <sup>3</sup>	$t_{SU}$		—	15	40	$\mu$ s

1. The nominal output impedance of an isolator driver channel is approximately 50  $\Omega$ ,  $\pm 40\%$ , which is a combination of the value of the on-chip series termination resistor and channel resistance of the output driver FET. When driving loads where transmission line effects will be a factor, output pins should be appropriately terminated with controlled impedance PCB traces.
2.  $t_{PSK(P-P)}$  is the magnitude of the difference in propagation delay times measured between different units operating at the same supply voltages, load, and ambient temperature.
3. Start-up time is the time period from the application of power to valid data at the output.

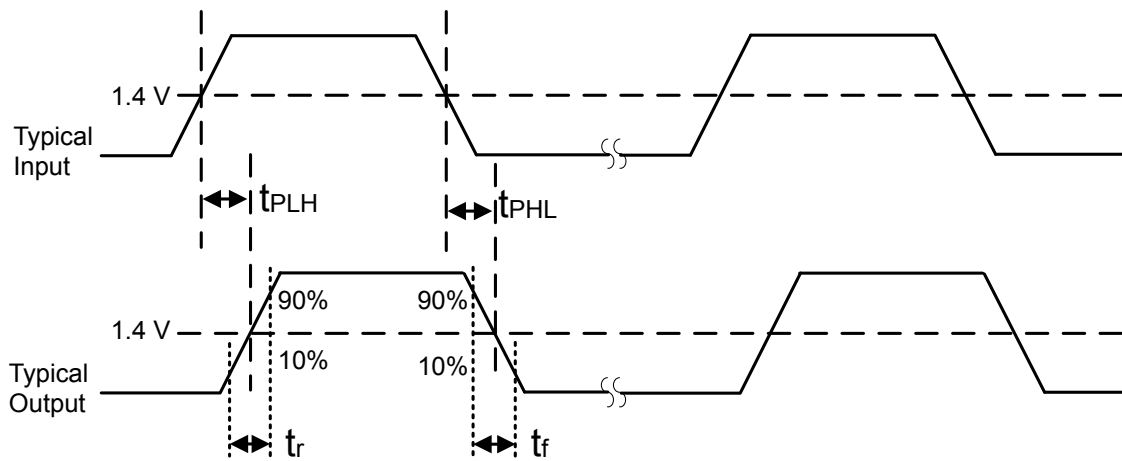

Figure 4.1. Propagation Delay Timing

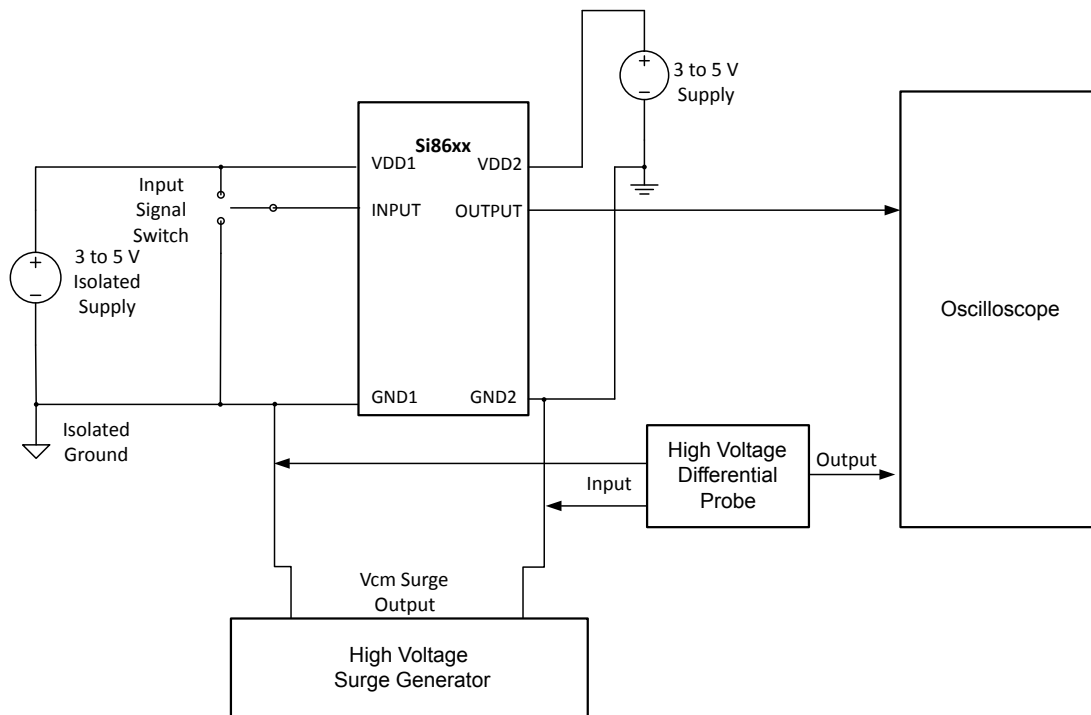

Figure 4.2. Common Mode Transient Immunity Test Circuit

Table 4.3. Electrical Characteristics

( $V_{DD1} = 3.3 \text{ V} \pm 10\%$ ,  $V_{DD2} = 3.3 \text{ V} \pm 10\%$ ,  $T_A = -40 \text{ to } 125 \text{ }^\circ\text{C}$ )

Parameter	Symbol	Test Condition	Min	Typ	Max	Unit
VDD Undervoltage Threshold	VDDUV+	$V_{DD1}$ , $V_{DD2}$ rising	1.95	2.24	2.375	V
VDD Undervoltage Threshold	VDDUV-	$V_{DD1}$ , $V_{DD2}$ falling	1.88	2.16	2.325	V
VDD Undervoltage Hysteresis	VDDHYS		50	70	95	mV
Positive-Going Input Threshold	VT+	All inputs rising	1.4	1.67	1.9	V
Negative-Going Input Threshold	VT-	All inputs falling	1.0	1.23	1.4	V
Input Hysteresis	VHYS		0.38	0.44	0.50	V
High Level Input Voltage	V <sub>IH</sub>		2.0	—	—	V
Low Level Input Voltage	V <sub>IL</sub>		—	—	0.8	V
High Level Output Voltage	V <sub>OH</sub>	$I_{OH} = -4 \text{ mA}$	$V_{DD1}, V_{DD2} - 0.4$	3.1	—	V
Low Level Output Voltage	V <sub>OL</sub>	$I_{OL} = 4 \text{ mA}$	—	0.2	0.4	V
Input Leakage Current	I <sub>L</sub>		—	—	$\pm 10$	$\mu\text{A}$
Output Impedance	Z <sub>O</sub>		—	50	—	$\Omega$
<b>DC Supply Current (All Inputs 0 V or at Supply)</b>						

Parameter	Symbol	Test Condition	Min	Typ	Max	Unit
<b>Si8660Bx, Ex</b>						
$V_{DD1}$		$V_I = 0(\text{Bx}), 1(\text{Ex})$	—	1.2	1.9	mA
$V_{DD2}$		$V_I = 0(\text{Bx}), 1(\text{Ex})$	—	3.5	5.3	
$V_{DD1}$		$V_I = 1(\text{Bx}), 0(\text{Ex})$	—	8.8	12.3	
$V_{DD2}$		$V_I = 1(\text{Bx}), 0(\text{Ex})$	—	3.7	5.6	
<b>Si8661Bx, Ex</b>						
$V_{DD1}$		$V_I = 0(\text{Bx}), 1(\text{Ex})$	—	1.7	2.7	mA
$V_{DD2}$		$V_I = 0(\text{Bx}), 1(\text{Ex})$	—	3.4	5.1	
$V_{DD1}$		$V_I = 1(\text{Bx}), 0(\text{Ex})$	—	7.9	11.1	
$V_{DD2}$		$V_I = 1(\text{Bx}), 0(\text{Ex})$	—	4.8	7.2	
<b>Si8662Bx, Ex</b>						
$V_{DD1}$		$V_I = 0(\text{Bx}), 1(\text{Ex})$	—	2.2	3.3	mA
$V_{DD2}$		$V_I = 0(\text{Bx}), 1(\text{Ex})$	—	3.0	4.5	
$V_{DD1}$		$V_I = 1(\text{Bx}), 0(\text{Ex})$	—	7.5	10.5	
$V_{DD2}$		$V_I = 1(\text{Bx}), 0(\text{Ex})$	—	5.6	8.4	
<b>Si8663Bx, Ex</b>						
$V_{DD1}$		$V_I = 0(\text{Bx}), 1(\text{Ex})$	—	2.6	3.9	mA
$V_{DD2}$		$V_I = 0(\text{Bx}), 1(\text{Ex})$	—	2.6	3.9	
$V_{DD1}$		$V_I = 1(\text{Bx}), 0(\text{Ex})$	—	6.5	9.1	
$V_{DD2}$		$V_I = 1(\text{Bx}), 0(\text{Ex})$	—	6.5	9.1	
<b>1 Mbps Supply Current (All Inputs = 500 kHz Square Wave, CI = 15 pF on All Outputs)</b>						
<b>Si8660Bx, Ex</b>						
$V_{DD1}$			—	5.0	7.0	mA
$V_{DD2}$			—	4.2	5.9	
<b>Si8661Bx, Ex</b>						
$V_{DD1}$			—	4.9	6.9	mA
$V_{DD2}$			—	4.6	6.4	
<b>Si8662Bx, Ex</b>						
$V_{DD1}$			—	5.1	7.1	mA
$V_{DD2}$			—	4.7	6.6	
<b>Si8663Bx, Ex</b>						
$V_{DD1}$			—	4.9	6.8	mA
$V_{DD2}$			—	4.9	6.8	
<b>10 Mbps Supply Current (All Inputs = 5 MHz Square Wave, CI = 15 pF on All Outputs)</b>						



Parameter	Symbol	Test Condition	Min	Typ	Max	Unit
<b>Si8660Bx, Ex</b>						
$V_{DD1}$			—	5.0	7.0	mA
$V_{DD2}$			—	5.0	7.0	
<b>Si8661Bx, Ex</b>						
$V_{DD1}$			—	5.0	7.0	mA
$V_{DD2}$			—	5.3	7.4	
<b>Si8662Bx, Ex</b>						
$V_{DD1}$			—	5.3	7.4	mA
$V_{DD2}$			—	5.2	7.3	
<b>Si8663Bx, Ex</b>						
$V_{DD1}$			—	5.2	7.3	mA
$V_{DD2}$			—	5.2	7.3	
<b>100 Mbps Supply Current (All Inputs = 50 MHz Square Wave, CI = 15 pF on All Outputs)</b>						
<b>Si8660Bx, Ex</b>						
$V_{DD1}$			—	5.0	7.0	mA
$V_{DD2}$			—	18.3	23.8	
<b>Si8661Bx, Ex</b>						
$V_{DD1}$			—	7.4	9.9	mA
$V_{DD2}$			—	16.4	21.3	
<b>Si8662Bx, Ex</b>						
$V_{DD1}$			—	10	13	mA
$V_{DD2}$			—	14.1	18.3	
<b>Si8663Bx, Ex</b>						
$V_{DD1}$			—	12.3	15.9	mA
$V_{DD2}$			—	12.3	15.9	
<b>Timing Characteristics</b>						
Si866xBx, Ex						
Maximum Data Rate			0	—	150	Mbps
Minimum Pulse Width			—	—	5.0	ns
Propagation Delay	$t_{PHL}, t_{PLH}$	See <a href="#">Figure 4.1 Propagation Delay Timing on page 14</a>	5.0	8.0	13	ns
Pulse Width Distortion $ t_{PLH} - t_{PHL} $	PWD	See <a href="#">Figure 4.1 Propagation Delay Timing on page 14</a>	—	0.2	4.5	ns
Propagation Delay Skew <sup>2</sup>	$t_{PSK(P-P)}$		—	2.0	4.5	ns
Channel-Channel Skew	$t_{PSK}$		—	0.4	2.5	ns
<b>All Models</b>						

Parameter	Symbol	Test Condition	Min	Typ	Max	Unit
Output Rise Time	$t_r$	$C_L = 15 \text{ pF}$ See <a href="#">Figure 4.1 Propagation Delay Timing on page 14</a>	—	2.5	4.0	ns
Output Fall Time	$t_f$	$C_L = 15 \text{ pF}$ See <a href="#">Figure 4.1 Propagation Delay Timing on page 14</a>	—	2.5	4.0	ns
Peak Eye Diagram Jitter	$t_{\text{JIT(PK)}}$	See <a href="#">Figure 2.3 Eye Diagram on page 6</a>	—	350	—	ps
Common Mode Transient Immunity	CMTI	$V_I = V_{DD}$ or 0 V $V_{CM} = 1500 \text{ V}$ (See <a href="#">Figure 4.2 Common Mode Transient Immunity Test Circuit on page 15</a> )	35	50	—	kV/ $\mu\text{s}$
Startup Time <sup>3</sup>	$t_{\text{SU}}$		—	15	40	$\mu\text{s}$

**Notes:**

1. The nominal output impedance of an isolator driver channel is approximately  $50 \Omega$ ,  $\pm 40\%$ , which is a combination of the value of the on-chip series termination resistor and channel resistance of the output driver FET. When driving loads where transmission line effects will be a factor, output pins should be appropriately terminated with controlled impedance PCB traces.
2.  $t_{\text{PSK(P-P)}}$  is the magnitude of the difference in propagation delay times measured between different units operating at the same supply voltages, load, and ambient temperature.
3. Start-up time is the time period from the application of power to valid data at the output.

Table 4.4. Electrical Characteristics

(V<sub>DD1</sub> = 2.5 V ±5%, V<sub>DD2</sub> = 2.5 V ±5%, T<sub>A</sub> = -40 to 125 °C)

Parameter	Symbol	Test Condition	Min	Typ	Max	Unit
VDD Undervoltage Threshold	VDDUV+	V <sub>DD1</sub> , V <sub>DD2</sub> rising	1.95	2.24	2.375	V
VDD Undervoltage Threshold	VDDUV-	V <sub>DD1</sub> , V <sub>DD2</sub> falling	1.88	2.16	2.325	V
VDD Undervoltage Hysteresis	VDDHYS		50	70	95	mV
Positive-Going Input Threshold	VT+	All inputs rising	1.4	1.67	1.9	V
Negative-Going Input Threshold	VT-	All inputs falling	1.0	1.23	1.4	V
Input Hysteresis	V <sub>HYS</sub>		0.38	0.44	0.50	V
High Level Input Voltage	V <sub>IH</sub>		2.0	—	—	V
Low Level Input Voltage	V <sub>IL</sub>		—	—	0.8	V
High Level Output Voltage	V <sub>OH</sub>	I <sub>oh</sub> = -4 mA	V <sub>DD1</sub> , V <sub>DD2</sub> - 0.4	2.3	—	V
Low Level Output Voltage	V <sub>OL</sub>	I <sub>ol</sub> = 4 mA	—	0.2	0.4	V
Input Leakage Current	I <sub>L</sub>		—	—	±10	μA
Output Impedance <sup>1</sup>	Z <sub>O</sub>		—	50	—	Ω
<b>DC Supply Current (All Inputs 0 V or at Supply)</b>						
<b>Si8660Bx, Ex</b>						
V <sub>DD1</sub>		V <sub>I</sub> = 0(Bx), 1(Ex)	—	1.2	1.9	mA
V <sub>DD2</sub>		V <sub>I</sub> = 0(Bx), 1(Ex)	—	3.5	5.3	
V <sub>DD1</sub>		V <sub>I</sub> = 1(Bx), 0(Ex)	—	8.8	12.3	
V <sub>DD2</sub>		V <sub>I</sub> = 1(Bx), 0(Ex)	—	3.7	5.6	
<b>Si8661Bx, Ex</b>						
V <sub>DD1</sub>		V <sub>I</sub> = 0(Bx), 1(Ex)	—	1.7	2.7	mA
V <sub>DD2</sub>		V <sub>I</sub> = 0(Bx), 1(Ex)	—	3.4	5.1	
V <sub>DD1</sub>		V <sub>I</sub> = 1(Bx), 0(Ex)	—	7.9	11.1	
V <sub>DD2</sub>		V <sub>I</sub> = 1(Bx), 0(Ex)	—	4.8	7.2	
<b>Si8662Bx, Ex</b>						
V <sub>DD1</sub>		V <sub>I</sub> = 0(Bx), 1(Ex)	—	2.2	3.3	mA
V <sub>DD2</sub>		V <sub>I</sub> = 0(Bx), 1(Ex)	—	3.0	4.5	
V <sub>DD1</sub>		V <sub>I</sub> = 1(Bx), 0(Ex)	—	7.5	10.5	
V <sub>DD2</sub>		V <sub>I</sub> = 1(Bx), 0(Ex)	—	5.6	8.4	

Parameter	Symbol	Test Condition	Min	Typ	Max	Unit
<b>Si8663Bx, Ex</b>						
$V_{DD1}$		$V_I = 0(\text{Bx}), 1(\text{Ex})$	—	2.6	3.9	mA
$V_{DD2}$		$V_I = 0(\text{Bx}), 1(\text{Ex})$	—	2.6	3.9	
$V_{DD1}$		$V_I = 1(\text{Bx}), 0(\text{Ex})$	—	6.5	9.1	
$V_{DD2}$		$V_I = 1(\text{Bx}), 0(\text{Ex})$	—	6.5	9.1	
<b>1 Mbps Supply Current (All Inputs = 500 kHz Square Wave, CI = 15 pF on All Outputs)</b>						
<b>Si8660Bx, Ex</b>						
$V_{DD1}$			—	5.0	7.0	mA
$V_{DD2}$			—	4.2	5.9	
<b>Si8661Bx, Ex</b>						
$V_{DD1}$			—	4.9	6.9	mA
$V_{DD2}$			—	4.6	6.4	
<b>Si8662Bx, Ex</b>						
$V_{DD1}$			—	5.1	7.1	mA
$V_{DD2}$			—	4.7	6.6	
<b>Si8663Bx, Ex</b>						
$V_{DD1}$			—	4.9	6.8	mA
$V_{DD2}$			—	4.9	6.8	
<b>10 Mbps Supply Current (All Inputs = 5 MHz Square Wave, CI = 15 pF on All Outputs)</b>						
<b>Si8660Bx, Ex</b>						
$V_{DD1}$			—	5.0	7.0	mA
$V_{DD2}$			—	4.6	6.4	
<b>Si8661Bx, Ex</b>						
$V_{DD1}$			—	5.0	6.9	mA
$V_{DD2}$			—	4.9	6.9	
<b>Si8662Bx, Ex</b>						
$V_{DD1}$			—	5.2	7.2	mA
$V_{DD2}$			—	4.9	6.9	
<b>Si8663Bx, Ex</b>						
$V_{DD1}$			—	5.0	7.0	mA
$V_{DD2}$			—	5.0	7.0	
<b>100 Mbps Supply Current (All Inputs = 50 MHz Square Wave, CI = 15 pF on All Outputs)</b>						
<b>Si8660Bx, Ex</b>						
$V_{DD1}$			—	5.0	7.0	mA
$V_{DD2}$			—	14.7	19.1	

Parameter	Symbol	Test Condition	Min	Typ	Max	Unit
<b>Si8661Bx, Ex</b>						
$V_{DD1}$			—	6.7	9.1	mA
$V_{DD2}$			—	13.4	17.4	
<b>Si8662Bx, Ex</b>						
$V_{DD1}$			—	8.7	11.3	mA
$V_{DD2}$			—	11.7	15.2	
<b>Si8663Bx, Ex</b>						
$V_{DD1}$			—	10.3	13.4	mA
$V_{DD2}$			—	10.3	13.4	
<b>Timing Characteristics</b>						
Si866xBx, Ex						
Maximum Data Rate			0	—	150	Mbps
Minimum Pulse Width			—	—	5.0	ns
Propagation Delay	$t_{PHL}, t_{PLH}$	See <a href="#">Figure 4.1 Propagation Delay Timing on page 14</a>	5.0	8.0	14	ns
Pulse Width Distortion $ t_{PLH} - t_{PHL} $	PWD	See <a href="#">Figure 4.1 Propagation Delay Timing on page 14</a>	—	0.2	5.0	ns
Propagation Delay Skew <sup>2</sup>	$t_{PSK(P-P)}$		—	2.0	5.0	ns
Channel-Channel Skew	$t_{PSK}$		—	0.4	2.5	ns
<b>All Models</b>						
Output Rise Time	$t_r$	$C_L = 15\text{ pF}$ See <a href="#">Figure 4.1 Propagation Delay Timing on page 14</a>	—	2.5	4.0	ns
Output Fall Time	$t_f$	$C_L = 15\text{ pF}$ See <a href="#">Figure 4.1 Propagation Delay Timing on page 14</a>	—	2.5	4.0	ns
Peak Eye Diagram Jitter	$t_{JIT(PK)}$	See <a href="#">Figure 2.3 Eye Diagram on page 6</a>	—	350	—	ps
Common Mode Transient Immunity	CMTI	$V_I = V_{DD}$ or 0 V $V_{CM} = 1500\text{ V}$ (See <a href="#">Figure 4.2 Common Mode Transient Immunity Test Circuit on page 15</a> )	35	50	—	kV/ $\mu$ s
Startup Time <sup>3</sup>	$t_{SU}$		—	15	40	$\mu$ s
<b>Notes:</b>						
1. The nominal output impedance of an isolator driver channel is approximately 50 $\Omega$ , $\pm 40\%$ , which is a combination of the value of the on-chip series termination resistor and channel resistance of the output driver FET. When driving loads where transmission line effects will be a factor, output pins should be appropriately terminated with controlled impedance PCB traces.						
2. $t_{PSK(P-P)}$ is the magnitude of the difference in propagation delay times measured between different units operating at the same supply voltages, load, and ambient temperature.						
3. Start-up time is the time period from the application of power to valid data at the output.						

Table 4.5. Regulatory Information <sup>1</sup>

<b>CSA</b>	
The Si866x is certified under CSA Component Acceptance Notice 5A. For more details, see Master Contract Number 232873.	
60950-1, 62368-1: Up to 600 V <sub>RMS</sub> reinforced insulation working voltage; up to 1000 V <sub>RMS</sub> basic insulation working voltage.	
60601-1: Up to 250 V <sub>RMS</sub> working voltage and 2 MOPP (Means of Patient Protection).	
<b>VDE</b>	
The Si866x is certified according to VDE 0884-10. For more details, see certificate 40018443.	
0884-10: Up to 1200 V <sub>peak</sub> for basic insulation working voltage.	
60950-1: Up to 600 V <sub>RMS</sub> reinforced insulation working voltage; up to 1000 V <sub>RMS</sub> basic insulation working voltage.	
<b>UL</b>	
The Si866x is certified under UL1577 component recognition program. For more details, see File E257455.	
Rated up to 5000 V <sub>RMS</sub> isolation voltage for basic protection.	
<b>CQC</b>	
The Si866x is certified under GB4943.1-2011. For more details, see certificates CQC13001096110 and CQC13001096239.	
Rated up to 600 V <sub>RMS</sub> reinforced insulation working voltage; up to 1000 V <sub>RMS</sub> basic insulation working voltage.	
<b>Note:</b>	
1. Regulatory Certifications apply to 2.5 kV <sub>RMS</sub> rated devices which are production tested to 3.0 kV <sub>RMS</sub> for 1 sec. Regulatory Certifications apply to 3.75 kV <sub>RMS</sub> rated devices which are production tested to 4.5 kV <sub>RMS</sub> for 1 sec. Regulatory Certifications apply to 5.0 kV <sub>RMS</sub> rated devices which are production tested to 6.0 kV <sub>RMS</sub> for 1 sec. For more information, see <a href="#">1. Ordering Guide</a> .	

Table 4.6. Insulation and Safety-Related Specifications

Parameter	Symbol	Test Condition	Value			Unit
			WB SOIC-16	NB SOIC-16	QSOP-16	
Nominal External Air Gap (Clearance) <sup>1</sup>	CLR		8.0	4.9	3.6	mm
Nominal External Tracking (Creepage) <sup>1</sup>	CPG		8.0	4.01	3.6	mm
Minimum Internal Gap (Internal Clearance)	DTI		0.014	0.014	0.014	mm
Tracking Resistance	CTI or PTI	IEC60112	600	600	600	V <sub>RMS</sub>
Erosion Depth	ED		0.019	0.019	0.031	mm
Resistance (Input-Output) <sup>2</sup>	R <sub>IO</sub>		10 <sup>12</sup>	10 <sup>12</sup>	10 <sup>12</sup>	Ω
Capacitance (Input-Output) <sup>2</sup>	C <sub>IO</sub>	f = 1 MHz	2.0	2.0	2.0	pF
Input Capacitance <sup>3</sup>	C <sub>I</sub>		4.0	4.0	4.0	pF

Parameter	Symbol	Test Condition	Value			Unit
			WB SOIC-16	NB SOIC-16	QSOP-16	
<b>Note:</b>						
1. The values in this table correspond to the nominal creepage and clearance values. VDE certifies the clearance and creepage limits as 4.7 mm minimum for the NB SOIC-16 package and QSOP-16 packages and 8.5 mm minimum for the WB SOIC-16 package. UL does not impose a clearance and creepage minimum for component-level certifications. CSA certifies the clearance and creepage of the WB SOIC-16 package with designation "IS2" as 8 mm minimum. CSA certifies the clearance and creepage limits as 3.9 mm minimum for the NB SOIC 16, 3.6 mm minimum for the QSOP-16, and 7.6 mm minimum for the WB SOIC-16 package with package designation "IS" as listed in the data sheet.						
2. To determine resistance and capacitance, the Si86xx is converted into a 2-terminal device. Pins 1–8 are shorted together to form the first terminal and pins 9–16 are shorted together to form the second terminal. The parameters are then measured between these two terminals.						
3. Measured from input pin to ground.						

Table 4.7. IEC 60664-1 Ratings

Parameter	Test Conditions	Specification		
		WB SOIC-16	NB SOIC-16	QSOP-16
Basic Isolation Group	Material Group	I	I	I
Installation Classification	Rated Mains Voltages $\leq 150$ V <sub>RMS</sub>	I-IV	I-IV	I-IV
	Rated Mains Voltages $\leq 300$ V <sub>RMS</sub>	I-IV	I-III	I-III
	Rated Mains Voltages $\leq 400$ V <sub>RMS</sub>	I-III	I-II	I-II
	Rated Mains Voltages $\leq 600$ V <sub>RMS</sub>	I-III	I-II	I-II

Table 4.8. VDE 0884-10 Insulation Characteristics for Si86xxxx<sup>1</sup>

Parameter	Symbol	Test Condition	Characteristic			Unit
			WB SOIC-16	NB SOIC-16	QSOP-16	
Maximum Working Insulation Voltage	V <sub>IORM</sub>		1200	630	630	V <sub>peak</sub>
Input to Output Test Voltage	V <sub>PR</sub>	Method b1 (V <sub>IORM</sub> × 1.875 = V <sub>PR</sub> , 100% Production Test, t <sub>m</sub> = 1 sec, Partial Discharge < 5 pC)	2250	1182	1182	V <sub>peak</sub>
Transient Overvoltage	V <sub>IOTM</sub>	t = 60 sec	6000	6000	6000	V <sub>peak</sub>
Surge Voltage	V <sub>IOSM</sub>	Tested per IEC 60065 with surge voltage of 1.2 μs/50 μs Si866xxB/C/D tested with 4000 V	3077	3077	3077	V <sub>peak</sub>
Pollution Degree (DIN VDE 0110, Table 1)			2	2	2	
Insulation Resistance at T <sub>S</sub> , V <sub>IO</sub> = 500 V	R <sub>S</sub>		>10 <sup>9</sup>	>10 <sup>9</sup>	>10 <sup>9</sup>	Ω

**Note:**

1. Maintenance of the safety data is ensured by protective circuits. The Si86xxxx provides a climate classification of 40/125/21.

Table 4.9. VDE 0884-10 Safety Limiting Values<sup>1</sup>

Parameter	Symbol	Test Condition	Max			Unit
			WB SOIC-16	NB SOIC-16	QSOP-16	
Case Temperature	T <sub>S</sub>		150	150	150	°C
Safety Input, Output, or Supply Current	I <sub>S</sub>	θ <sub>JA</sub> = 100 °C/W (WB SOIC-16) 105 °C/W (NB SOIC-16, QSOP-16) V <sub>I</sub> = 5.5 V, T <sub>J</sub> = 150 °C, T <sub>A</sub> = 25 °C	220	215	215	mA
Device Power Dissipation <sup>2</sup>	P <sub>D</sub>		415	415	415	mW

**Note:**

- Maximum value allowed in the event of a failure; also see the thermal derating curve in [Figure 4.3 \(WB SOIC-16\) Thermal Derating Curve, Dependence of Safety Limiting Values with Case Temperature per VDE 0884-10 on page 25](#) and [Figure 4.4 \(NB SOIC-16, QSOP-16\) Thermal Derating Curve, Dependence of Safety Limiting Values with Case Temperature per VDE 0884-10 on page 25](#).
- The Si86xx is tested with VDD1 = VDD2 = 5.5 V; T<sub>J</sub> = 150 °C; C<sub>L</sub> = 15 pF, input a 150 Mbps 50% duty cycle square wave.

Table 4.10. Thermal Characteristics

Parameter	Symbol	WB SOIC-16	NB SOIC-16/QSOP-16	Unit
IC Junction-to-Air Thermal Resistance	θ <sub>JA</sub>	100	105	°C/W



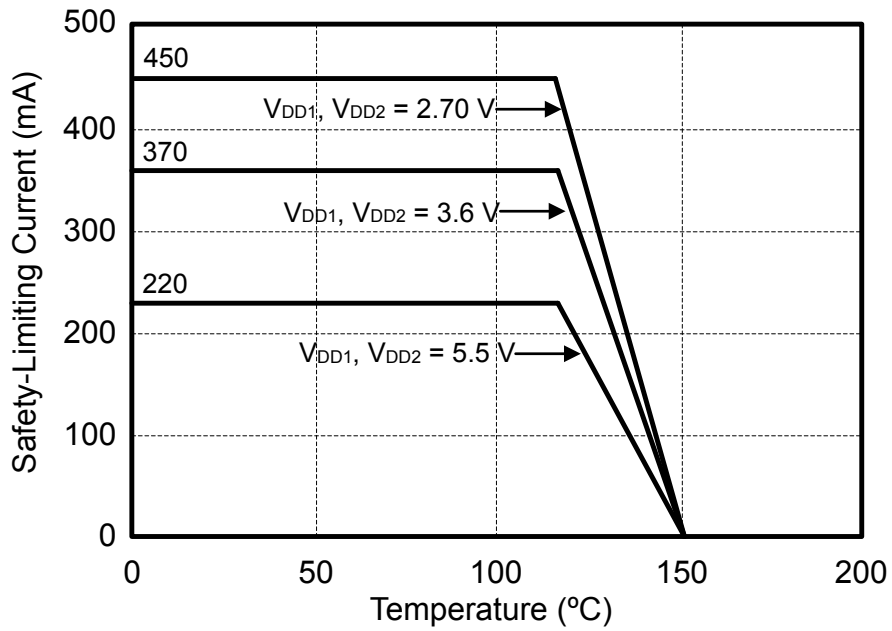

Figure 4.3. (WB SOIC-16) Thermal Derating Curve, Dependence of Safety Limiting Values with Case Temperature per VDE 0884-10

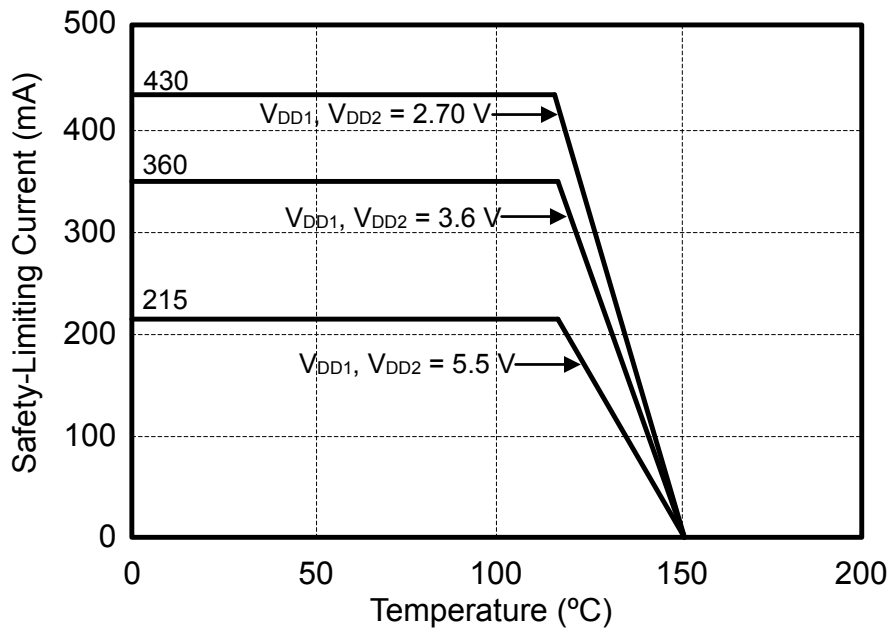

Figure 4.4. (NB SOIC-16, QSOP-16) Thermal Derating Curve, Dependence of Safety Limiting Values with Case Temperature per VDE 0884-10

Table 4.11. Absolute Maximum Ratings <sup>1</sup>

Parameter	Symbol	Min	Max	Unit
Storage Temperature <sup>2</sup>	$T_{STG}$	-65	150	°C
Ambient Temperature Under Bias	$T_A$	-40	125	°C
Junction Temperature	$T_J$	—	150	°C
Supply Voltage	$V_{DD1}, V_{DD2}$	-0.5	7.0	V
Input Voltage	$V_I$	-0.5	$V_{DD} + 0.5$	V
Output Voltage	$V_O$	-0.5	$V_{DD} + 0.5$	V
Output Current Drive Channel	$I_O$	—	10	mA
Lead Solder Temperature (10 s)		—	260	°C
Maximum Isolation (Input to Output) (1 sec) NB SOIC-16, QSOP-16		—	4500	$V_{RMS}$
Maximum Isolation (Input to Output) (1 sec) WB SOIC-16		—	6500	$V_{RMS}$

**Notes:**

1. Permanent device damage may occur if the absolute maximum ratings are exceeded. Functional operation should be restricted to conditions as specified in the operational sections of this data sheet.
2. VDE certifies storage temperature from -40 to 150 °C.

## 5. Pin Descriptions

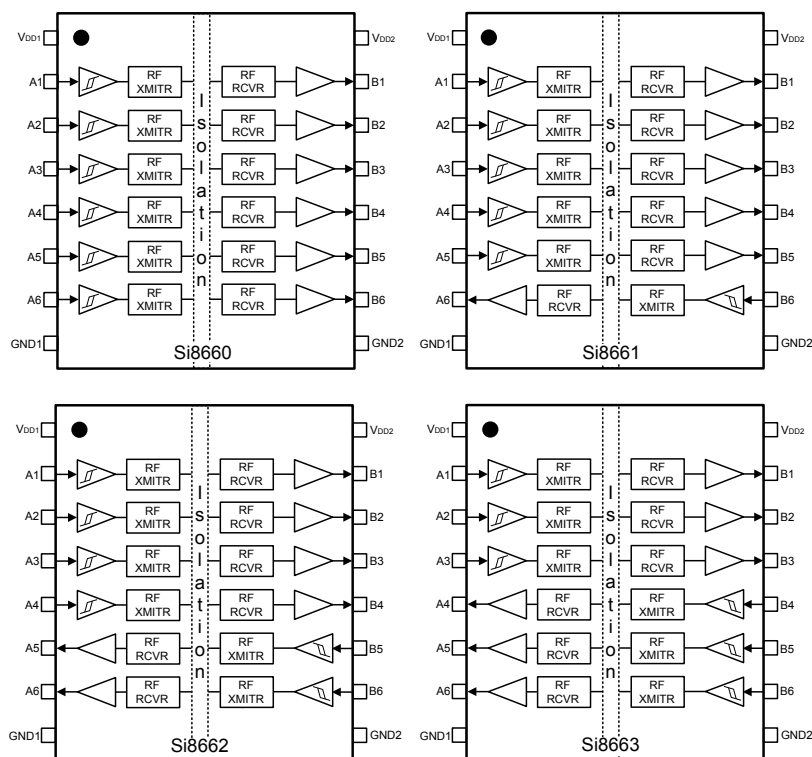

Figure 5.1. Si866x Pinout

Table 5.1. Si866x Pin Descriptions

Name	SOIC-16 Pin#	Type	Description
V <sub>DD1</sub>	1	Supply	Side 1 power supply.
A1	2	Digital Input	Side 1 digital input.
A2	3	Digital Input	Side 1 digital input.
A3	4	Digital Input	Side 1 digital input.
A4	5	Digital I/O	Side 1 digital input or output.
A5	6	Digital I/O	Side 1 digital input or output.
A6	7	Digital I/O	Side 1 digital input or output.
GND1	8	Ground	Side 1 ground.
GND2	9	Ground	Side 2 ground.
B6	10	Digital I/O	Side 2 digital input or output.
B5	11	Digital I/O	Side 2 digital input or output.
B4	12	Digital I/O	Side 2 digital input or output.
B3	13	Digital Output	Side 2 digital output.
B2	14	Digital Output	Side 2 digital output.
B1	15	Digital Output	Side 2 digital output.
V <sub>DD2</sub>	16	Supply	Side 2 power supply.

## 6. Package Outline (16-Pin Wide Body SOIC)

The figure below illustrates the package details for the Si86xx digital isolator in a 16-pin wide-body SOIC package. The table below lists the values for the dimensions shown in the illustration.

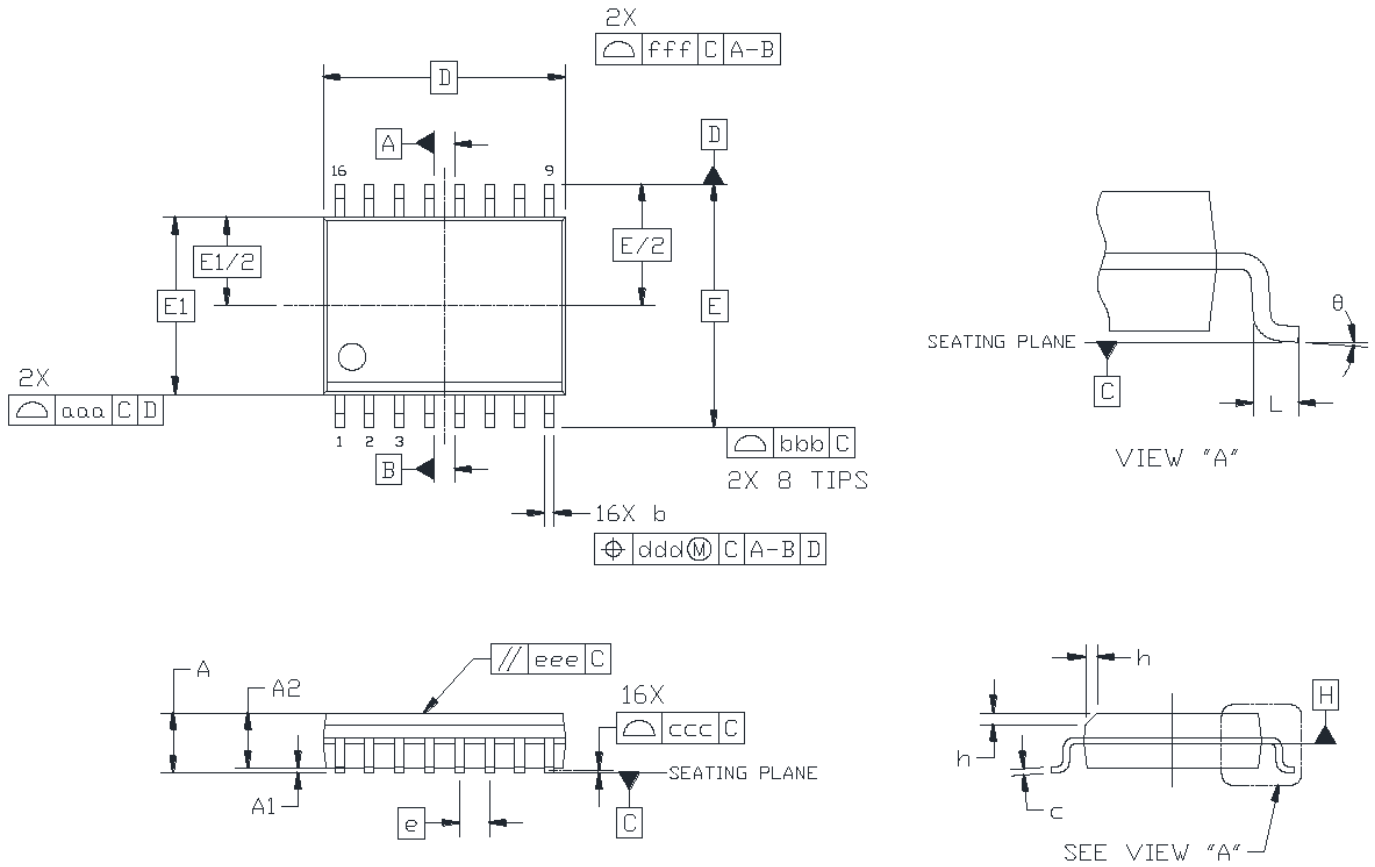

Figure 6.1. 16-Pin Wide Body SOIC

Table 6.1. 16-Pin Wide Body SOIC Package Diagram Dimensions

Dimension	Min	Max
A	—	2.65
A1	0.10	0.30
A2	2.05	—
b	0.31	0.51
c	0.20	0.33
D	10.30 BSC	
E	10.30 BSC	
E1	7.50 BSC	
e	1.27 BSC	
L	0.40	1.27
h	0.25	0.75
$\theta$	0°	8°
aaa	—	0.10
bbb	—	0.33
ccc	—	0.10
ddd	—	0.25
eee	—	0.10
fff	—	0.20

**Notes:**

1. All dimensions shown are in millimeters (mm) unless otherwise noted.
2. Dimensioning and Tolerancing per ANSI Y14.5M-1994.
3. This drawing conforms to JEDEC Outline MS-013, Variation AA.
4. Recommended reflow profile per JEDEC J-STD-020 specification for small body, lead-free components.

## 7. Land Pattern (16-Pin Wide-Body SOIC)

The figure below illustrates the recommended land pattern details for the Si86xx in a 16-pin wide-body SOIC package. The table below lists the values for the dimensions shown in the illustration.

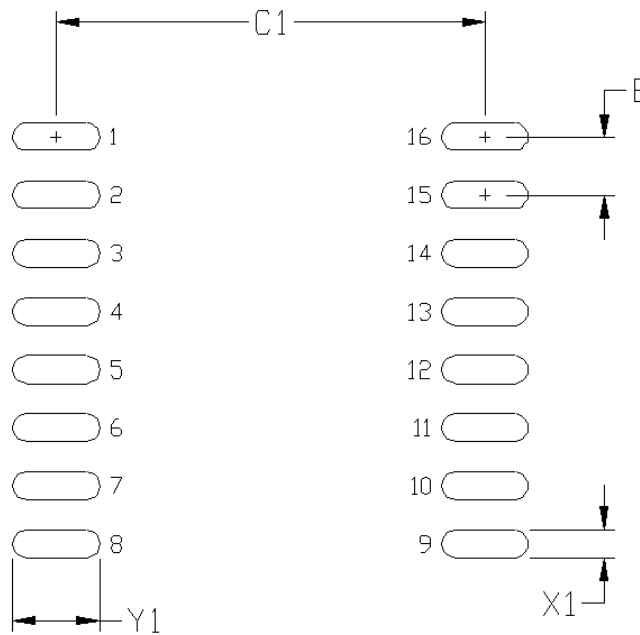

**Figure 7.1. 16-Pin Wide Body SOIC PCB Land Pattern**

**Table 7.1. 16-Pin Wide Body SOIC Land Pattern Dimensions**

Dimension	Feature	(mm)
C1	Pad Column Spacing	9.40
E	Pad Row Pitch	1.27
X1	Pad Width	0.60
Y1	Pad Length	1.90

**Notes:**

1. This Land Pattern Design is based on IPC-7351 pattern SOIC127P1032X265-16AN for Density Level B (Median Land Protrusion).
2. All feature sizes shown are at Maximum Material Condition (MMC) and a card fabrication tolerance of 0.05 mm is assumed.

### 8. Package Outline (16-Pin Narrow Body SOIC)

The figure below illustrates the package details for the Si86xx in a 16-pin narrow-body SOIC package. The table below lists the values for the dimensions shown in the illustration.

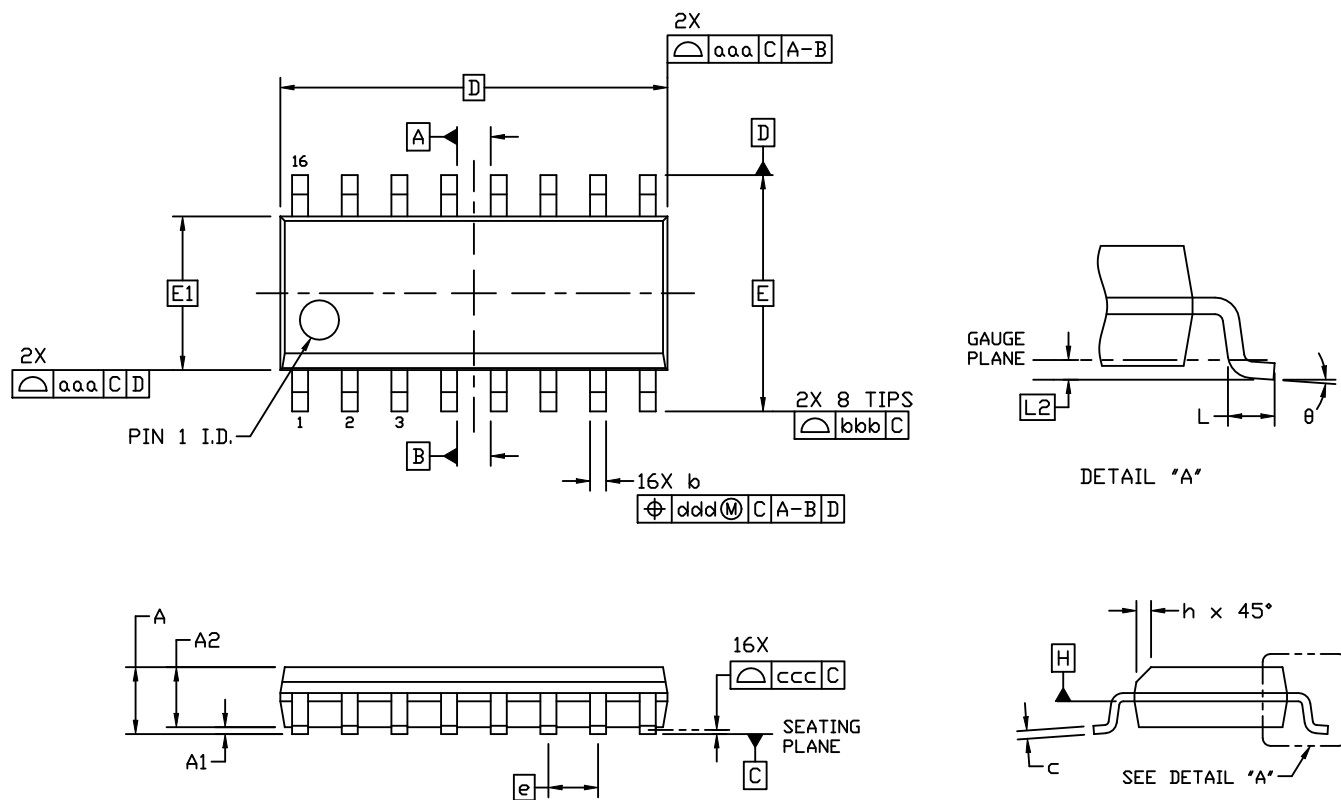

Figure 8.1. 16-Pin Narrow Body SOIC

Table 8.1. 16-Pin Narrow Body SOIC Package Diagram Dimensions

Dimension	Min	Max
A	—	1.75
A1	0.10	0.25
A2	1.25	—
b	0.31	0.51
c	0.17	0.25
D	9.90 BSC	
E	6.00 BSC	
E1	3.90 BSC	
e	1.27 BSC	
L	0.40	1.27
L2	0.25 BSC	
h	0.25	0.50
$\theta$	0°	8°
aaa	0.10	
bbb	0.20	
ccc	0.10	
ddd	0.25	

**Notes:**

1. All dimensions shown are in millimeters (mm) unless otherwise noted.
2. Dimensioning and Tolerancing per ANSI Y14.5M-1994.
3. This drawing conforms to the JEDEC Solid State Outline MS-012, Variation AC.
4. Recommended card reflow profile is per the JEDEC/IPC J-STD-020 specification for Small Body Components.



### 9. Land Pattern (16-Pin Narrow Body SOIC)

The figure below illustrates the recommended land pattern details for the Si86xx in a 16-pin narrow-body SOIC package. The table below lists the values for the dimensions shown in the illustration.

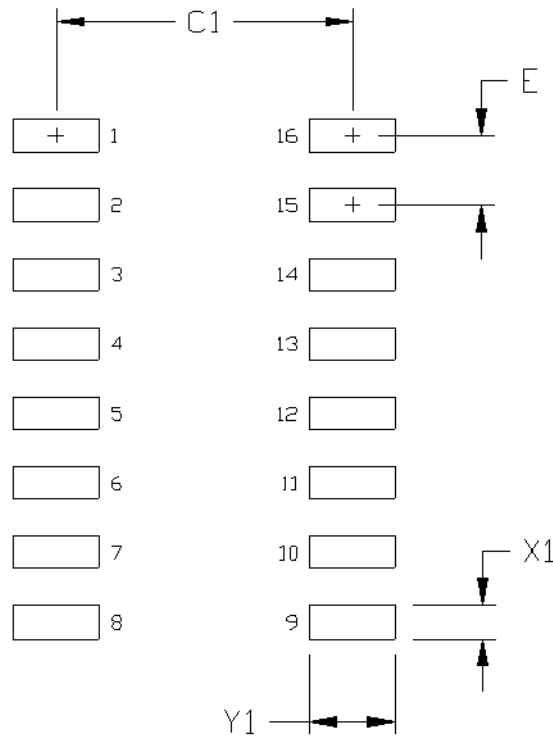

**Figure 9.1. 16-Pin Narrow Body SOIC PCB Land Pattern**

**Table 9.1. 16-Pin Narrow Body SOIC Land Pattern Dimensions**

Dimension	Feature	(mm)
C1	Pad Column Spacing	5.40
E	Pad Row Pitch	1.27
X1	Pad Width	0.60
Y1	Pad Length	1.55

**Notes:**

1. This Land Pattern Design is based on IPC-7351 pattern SOIC127P600X165-16N for Density Level B (Median Land Protrusion).
2. All feature sizes shown are at Maximum Material Condition (MMC) and a card fabrication tolerance of 0.05 mm is assumed.

10. Package Outline (16-Pin QSOP)

The figure below illustrates the package details for the Si86xx in a 16-pin QSOP package. The table lists the values for the dimensions shown in the illustration.

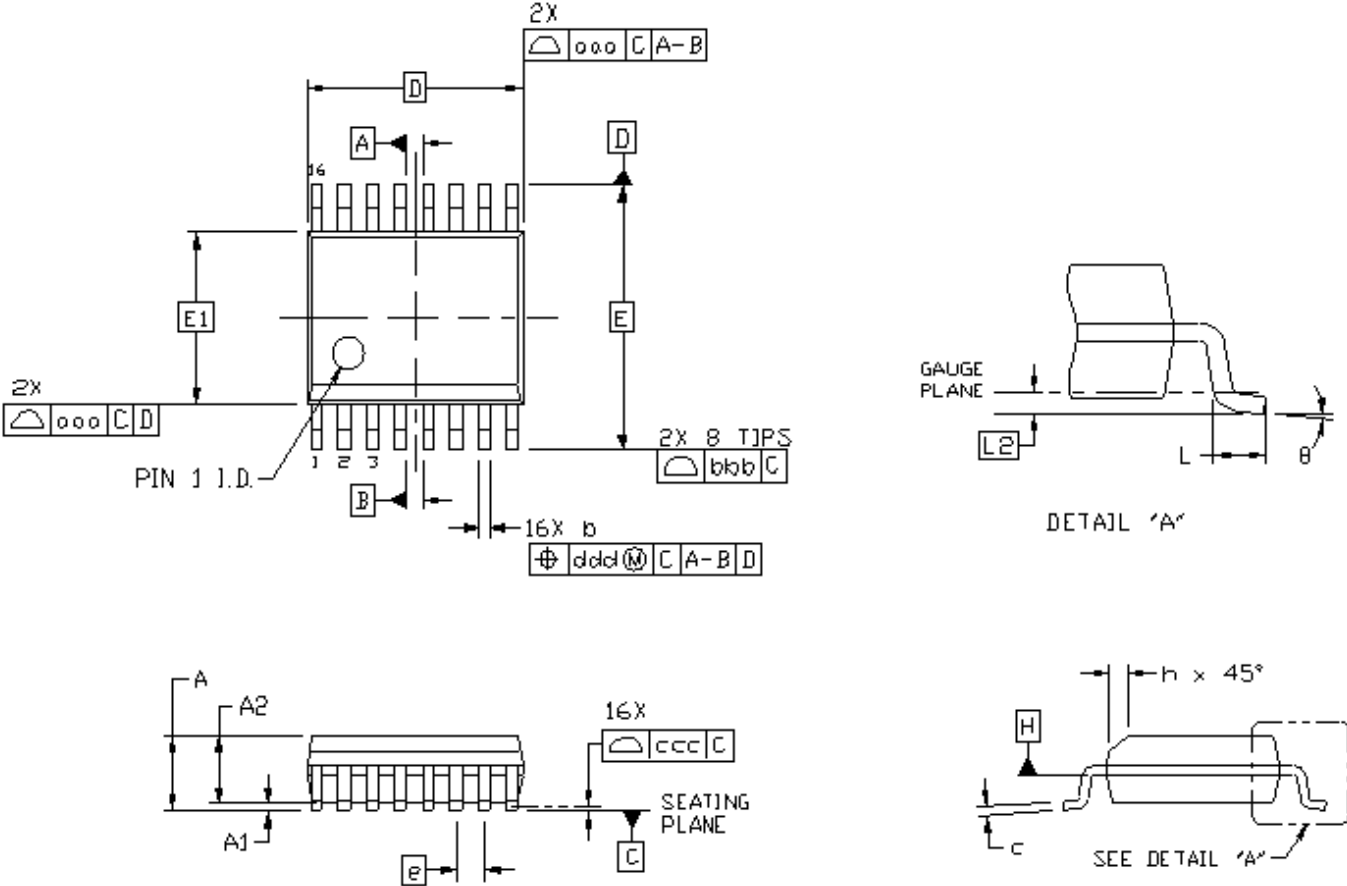

Figure 10.1. 16-Pin QSOP Package

Table 10.1. 16-Pin QSOP Package Diagram Dimensions<sup>1, 2, 3, 4</sup>

Dimension	Min	Max
A	—	1.75
A1	0.10	0.25
A2	1.25	—
b	0.20	0.30
c	0.17	0.25
D	4.89 BSC	
E	6.00 BSC	
E1	3.90 BSC	
e	0.635 BSC	
L	0.40	1.27
L2	0.25 BSC	
h	0.25	0.50
θ	0°	8°
aaa	0.10	
bbb	0.20	
ccc	0.10	
ddd	0.25	

**Note:**

1. All dimensions shown are in millimeters (mm) unless otherwise noted.
2. Dimensioning and Tolerancing per ANSI Y14.5M-1994.
3. This drawing conforms to the JEDEC Solid State Outline MO-137, Variation AB.
4. Recommended card reflow profile is per the JEDEC/IPC J-STD-020 specification for Small Body Components.

## 11. Land Pattern (16-Pin QSOP)

The figure below illustrates the recommended land pattern details for the Si86xx in a 16-pin QSOP package. The table lists the values for the dimensions shown in the illustration.

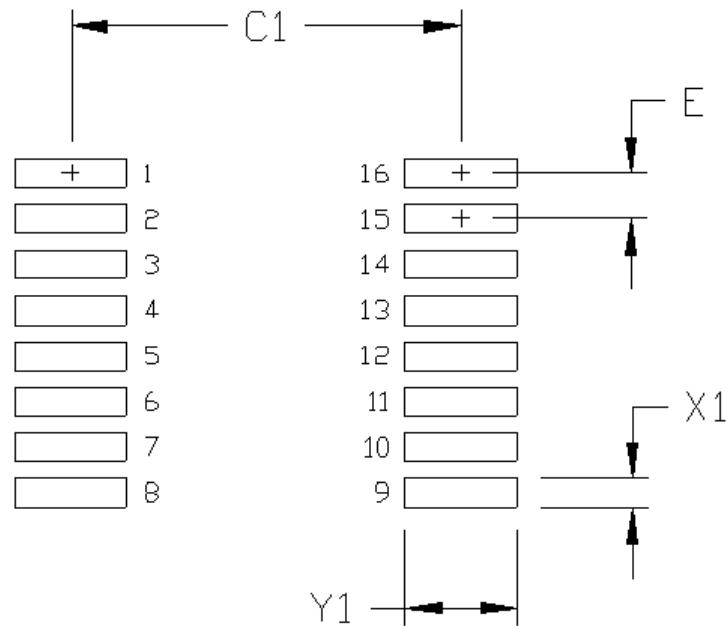

Figure 11.1. 16-Pin QSOP PCB Land Pattern

Table 11.1. 16-Pin QSOP Land Pattern Dimensions<sup>1, 2</sup>

Dimension	Feature	(mm)
C1	Pad Column Spacing	5.40
E	Pad Row Pitch	0.635
X1	Pad Width	0.40
Y1	Pad Length	1.55

**Note:**

1. This Land Pattern Design is based on IPC-7351 pattern SOP63P602X173-16N for Density Level B (Median Land Protrusion).
2. All feature sizes shown are at Maximum Material Condition (MMC) and a card fabrication tolerance of 0.05 mm is assumed.

## 12. Top Marking (16-Pin Wide Body SOIC)

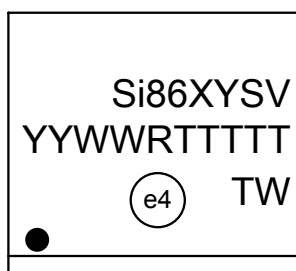

Figure 12.1. 16-Pin Wide Body SOIC Top Marking

Table 12.1. 16-Pin Wide Body SOIC Top Marking Explanation

<b>Line 1 Marking:</b>	Base Part Number Ordering Options (See <a href="#">1. Ordering Guide</a> for more information.)	Si86 = Isolator product series XY = Channel Configuration X = # of data channels (6) Y = # of reverse channels (3, 2, 1, 0) S = Speed Grade A = 1 Mbps B = 150 Mbps (default output = low) E = 150 Mbps (default output = high) V = Insulation rating A = 1 kV; B = 2.5 kV; C = 3.75 kV; D = 5.0 kV
<b>Line 2 Marking:</b>	YY = Year WW = Workweek	Assigned by assembly subcontractor. Corresponds to the year and workweek of the mold date.
	RTTTTT = Mfg Code	Manufacturing code from assembly house "R" indicates revision
<b>Line 3 Marking:</b>	Circle = 1.7 mm Diameter (Center-Justified)	"e4" Pb-Free Symbol
	Country of Origin ISO Code Abbreviation	TW = Taiwan as shown, TH = Thailand

## 13. Top Marking (16-Pin Narrow Body SOIC)

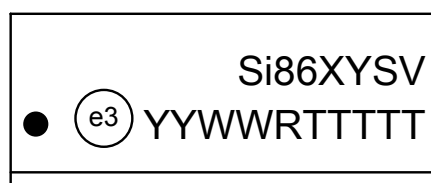

Figure 13.1. 16-Pin Narrow Body SOIC Top Marking

Table 13.1. 16-Pin Narrow Body SOIC Top Marking Explanation

<b>Line 1 Marking:</b>	Base Part Number	Si86 = Isolator product series
	Ordering Options (See <a href="#">1. Ordering Guide</a> for more information.)	XY = Channel Configuration X = # of data channels (6) Y = # of reverse channels (3, 2, 1, 0) S = Speed Grade A = 1 Mbps B = 150 Mbps (default output = low) E = 150 Mbps (default output = high) V = Insulation rating A = 1 kV; B = 2.5 kV; C = 3.75 kV
<b>Line 2 Marking:</b>	Circle = 1.2 mm Diameter	"e3" Pb-Free Symbol
	YY = Year	Assigned by the Assembly House. Corresponds to the year and work week of the mold date.
	WW = Work Week	
	RTTTTT = Mfg Code	Manufacturing code from assembly house. "R" indicates revision.
Circle = 1.2 mm diameter	"e3" Pb-Free Symbol.	

## 14. Top Marking (16-Pin QSOP)

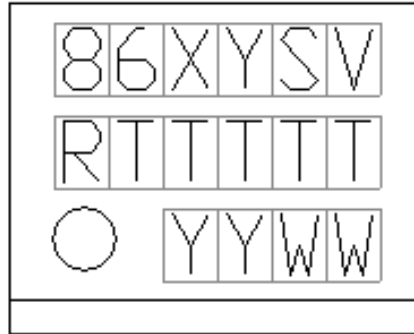

Figure 14.1. 16-Pin QSOP Top Marking

Table 14.1. 16-Pin QSOP Top Marking Explanation

<p><b>Line 1 Marking:</b></p>	<p>Base Part Number                  Ordering Options                  (See <a href="#">1. Ordering Guide</a> for more information).</p>	<p>86 = Isolator product series                  XY = Channel Configuration                  X = # of data channels (6)                  Y = # of reverse channels (3, 2, 1, 0)                  S = Speed Grade (max data rate) and operating mode:                  B = 150 Mbps (default output = low)                  E = 150 Mbps (default output = high)                  V = Insulation rating                  A = 1 kV; B = 2.5 kV; C = 3.75 kV</p>
<p><b>Line 2 Marking:</b></p>	<p>RTTTTT = Mfg Code</p>	<p>Manufacturing code from assembly house                  "R" indicates revision</p>
<p><b>Line 3 Marking:</b></p>	<p>YY = Year                  WW = Work Week</p>	<p>Assigned by the Assembly House. Corresponds to the year and work week of the mold date.</p>

## 15. Document Change List

### Revision 0.1

September 15, 2010

- Initial release.

### Revision 0.1 to Revision 1.0

March 31, 2011

- Added chip graphics on front page.
- Updated features list on front page.
- Moved [Table 4.1 Recommended Operating Conditions on page 11](#) and [Table 4.11 Absolute Maximum Ratings <sup>1</sup> on page 26](#).
- Updated [4. Electrical Specifications](#).
- Moved [Table 3.1 Si866x Logic Operation on page 7](#).
- Moved and updated [3.5 Typical Performance Characteristics](#).
- Updated [Table 5.1 Si866x Pin Descriptions on page 27](#).
- Updated [1. Ordering Guide](#).
- Removed references to QSOP-16 package.

### Revision 1.0 to Revision 1.1

July 14, 2011

- Reordered spec tables to conform to new convention.
- Removed “pending” throughout document.

### Revision 1.1 to Revision 1.2

September 14, 2011

- Reordered spec tables to conform to new convention.
- Removed “pending” throughout document.

### Revision 1.2 to Revision 1.3

March 21, 2012

- Updated [1. Ordering Guide](#) to include MSL2A.

### Revision 1.3 to Revision 1.4

June 26, 2012

- Updated [Table 4.11 Absolute Maximum Ratings <sup>1</sup> on page 26](#).
  - Added junction temperature spec.
- Updated [3.3.1 Supply Bypass](#).
- Removed “3.3.2. Pin Connections”.
- Updated [1. Ordering Guide](#).
  - Removed Rev A devices.
- Updated [6. Package Outline \(16-Pin Wide Body SOIC\)](#).
- Updated Top Marks.
  - Added revision description.

### Revision 1.4 to Revision 1.5

September 25, 2013

- Added [Figure 4.2 Common Mode Transient Immunity Test Circuit on page 15](#).
- Added references to CQC throughout.
- Added references to 2.5 kVRMS devices throughout.
- Updated [1. Ordering Guide](#).



- Updated [12. Top Marking \(16-Pin Wide Body SOIC\)](#).

#### Revision 1.5 to Revision 1.6

June 18, 2015

- Updated [Table 4.5 Regulatory Information](#) <sup>1</sup> on page 22.
  - Added CQC certificate numbers.
- Updated [1. Ordering Guide](#).
  - Removed references to moisture sensitivity levels.
  - Removed Note 2.
- Added note to [Table 1.1 Ordering Guide for Valid OPNs](#) <sup>1,2, 3</sup> on page 2 for denoting tape and reel marking.

#### Revision 1.6 to Revision 1.7

October 18, 2017

- Added new OPNs in Ordering Guide for IU (QSOP) and IS2 (8 mm creepage WB SOIC) package options.
- Added 62368-1 references throughout.
- Removed 61010-1 references throughout.
- Added QSOP-16 package information.

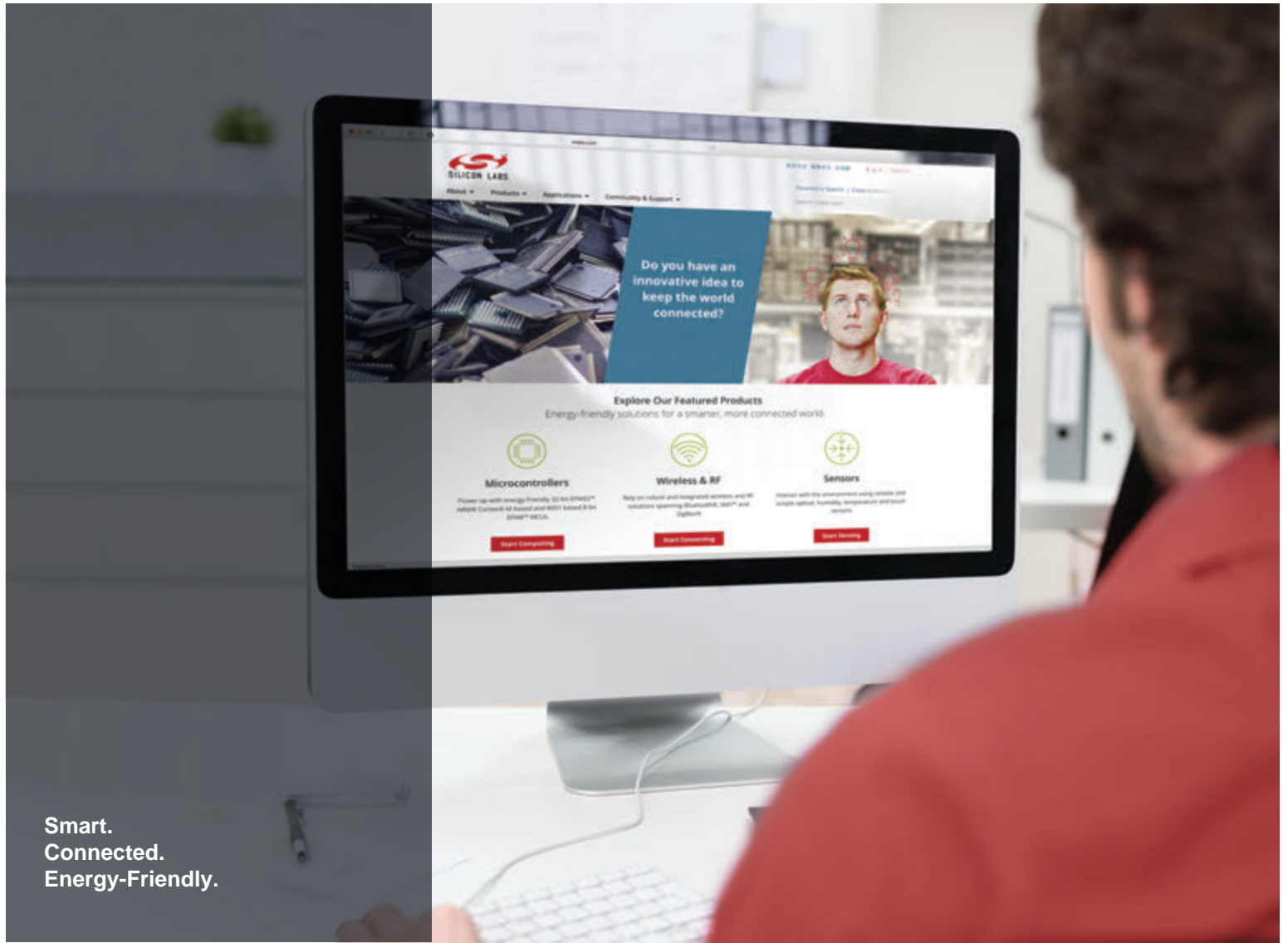

Smart.  
Connected.  
Energy-Friendly.



**Products**  
[www.silabs.com/products](http://www.silabs.com/products)

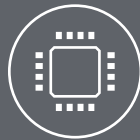

**Quality**  
[www.silabs.com/quality](http://www.silabs.com/quality)



**Support and Community**  
[community.silabs.com](http://community.silabs.com)

**Disclaimer**  
Silicon Labs intends to provide customers with the latest, accurate, and in-depth documentation of all peripherals and modules available for system and software implementers using or intending to use the Silicon Labs products. Characterization data, available modules and peripherals, memory sizes and memory addresses refer to each specific device, and "Typical" parameters provided can and do vary in different applications. Application examples described herein are for illustrative purposes only. Silicon Labs reserves the right to make changes without further notice and limitation to product information, specifications, and descriptions herein, and does not give warranties as to the accuracy or completeness of the included information. Silicon Labs shall have no liability for the consequences of use of the information supplied herein. This document does not imply or express copyright licenses granted hereunder to design or fabricate any integrated circuits. The products are not designed or authorized to be used within any Life Support System without the specific written consent of Silicon Labs. A "Life Support System" is any product or system intended to support or sustain life and/or health, which, if it fails, can be reasonably expected to result in significant personal injury or death. Silicon Labs products are not designed or authorized for military applications. Silicon Labs products shall under no circumstances be used in weapons of mass destruction including (but not limited to) nuclear, biological or chemical weapons, or missiles capable of delivering such weapons.

**Trademark Information**

Silicon Laboratories Inc.®, Silicon Laboratories®, Silicon Labs®, SiLabs® and the Silicon Labs logo®, Bluegiga®, Bluegiga Logo®, Clockbuilder®, CMEMS®, DSPLL®, EFM®, EFM32®, EFR®, Ember®, Energy Micro, Energy Micro logo and combinations thereof, "the world's most energy friendly microcontrollers", Ember®, EZLink®, EZRadio®, EZRadioPRO®, Gecko®, ISOModem®, Micrium, Precision32®, ProSLIC®, Simplicity Studio®, SiPHY®, Telegesis, the Telegesis Logo®, USBXpress®, Zentri and others are trademarks or registered trademarks of Silicon Labs. ARM, CORTEX, Cortex-M3 and THUMB are trademarks or registered trademarks of ARM Holdings. Keil is a registered trademark of ARM Limited. All other products or brand names mentioned herein are trademarks of their respective holders.



Silicon Laboratories Inc.  
400 West Cesar Chavez  
Austin, TX 78701  
USA

<http://www.silabs.com>

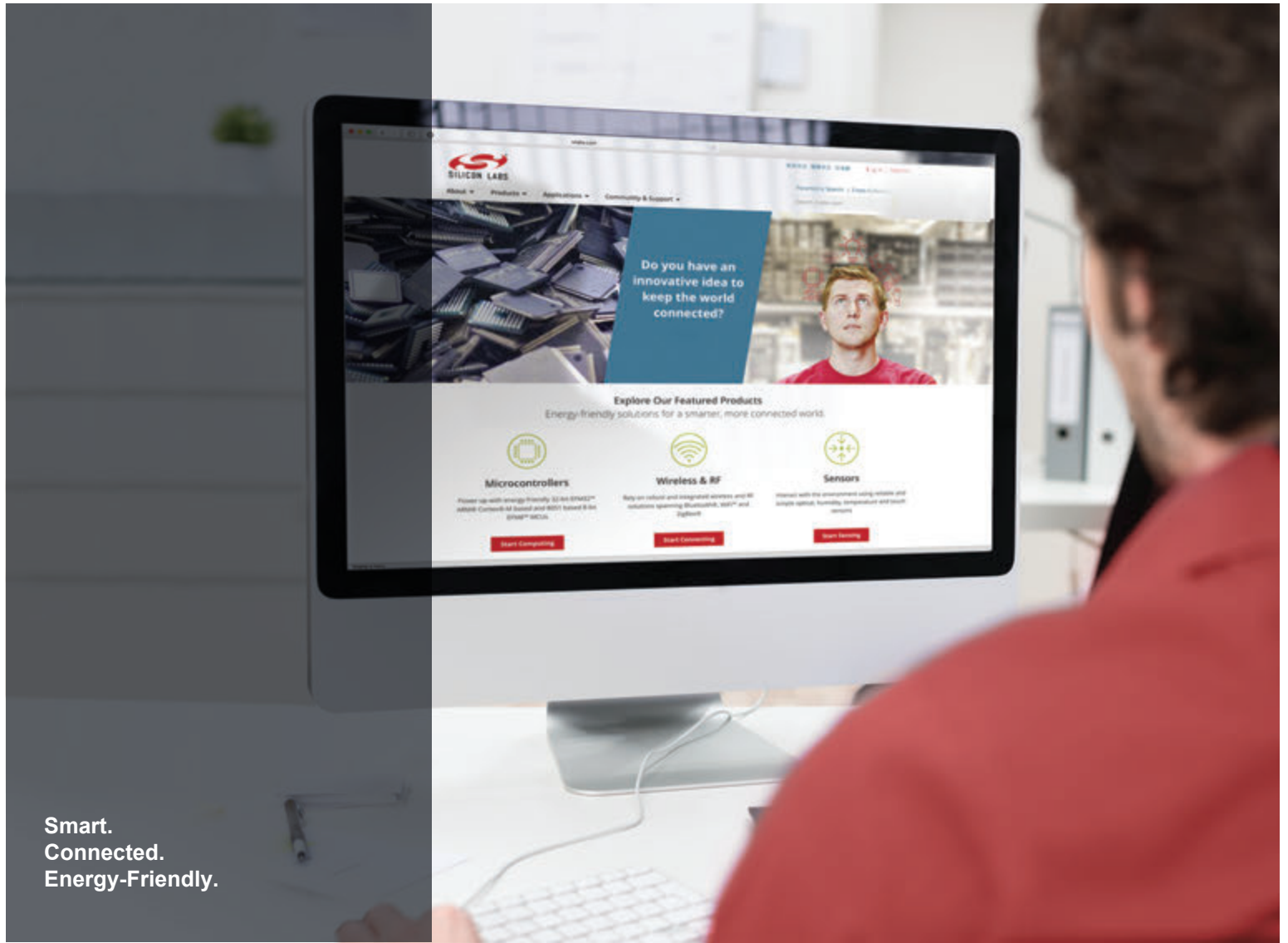

Smart.  
Connected.  
Energy-Friendly.



**Products**  
[www.silabs.com/products](http://www.silabs.com/products)



**Quality**  
[www.silabs.com/quality](http://www.silabs.com/quality)



**Support and Community**  
[community.silabs.com](http://community.silabs.com)

**Disclaimer**  
Silicon Labs intends to provide customers with the latest, accurate, and in-depth documentation of all peripherals and modules available for system and software implementers using or intending to use the Silicon Labs products. Characterization data, available modules and peripherals, memory sizes and memory addresses refer to each specific device, and "Typical" parameters provided can and do vary in different applications. Application examples described herein are for illustrative purposes only. Silicon Labs reserves the right to make changes without further notice and limitation to product information, specifications, and descriptions herein, and does not give warranties as to the accuracy or completeness of the included information. Silicon Labs shall have no liability for the consequences of use of the information supplied herein. This document does not imply or express copyright licenses granted hereunder to design or fabricate any integrated circuits. The products are not designed or authorized to be used within any Life Support System without the specific written consent of Silicon Labs. A "Life Support System" is any product or system intended to support or sustain life and/or health, which, if it fails, can be reasonably expected to result in significant personal injury or death. Silicon Labs products are not designed or authorized for military applications. Silicon Labs products shall under no circumstances be used in weapons of mass destruction including (but not limited to) nuclear, biological or chemical weapons, or missiles capable of delivering such weapons.

**Trademark Information**

Silicon Laboratories Inc.®, Silicon Laboratories®, Silicon Labs®, SiLabs® and the Silicon Labs logo®, Bluegiga®, Bluegiga Logo®, Clockbuilder®, CMEMS®, DSPLL®, EFM®, EFM32®, EFR®, Ember®, Energy Micro, Energy Micro logo and combinations thereof, "the world's most energy friendly microcontrollers", Ember®, EZLink®, EZRadio®, EZRadioPRO®, Gecko®, ISOModem®, Micrium, Precision32®, ProSLIC®, Simplicity Studio®, SiPHY®, Telegesis, the Telegesis Logo®, USBXpress®, Zentri and others are trademarks or registered trademarks of Silicon Labs. ARM, CORTEX, Cortex-M3 and THUMB are trademarks or registered trademarks of ARM Holdings. Keil is a registered trademark of ARM Limited. All other products or brand names mentioned herein are trademarks of their respective holders.



Silicon Laboratories Inc.  
400 West Cesar Chavez  
Austin, TX 78701  
USA

<http://www.silabs.com>